

# FURUNO

## OPERATOR'S MANUAL

COLOR SCANNING SONAR

MODEL CSH-5 MARK-2



**FURUNO ELECTRIC CO., LTD.**  
NISHINOMIYA, JAPAN

© **FURUNO ELECTRIC CO., LTD.**

9-52, Ashihara-cho,  
Nishinomiya, Japan

Telephone: 0798-65-2111  
Telefax: 0798-65-4200

•Your Local Agent/Dealer

All rights reserved.

Printed in Japan

FIRST EDITION : NOV. 1995  
E : DEC. 6, 2000

(DAMI)

PUB. No. OME-12990  
CSH-5 MARK2



\* 00080739100 \*



# SAFETY INSTRUCTIONS



## WARNING



**ELECTRICAL SHOCK HAZARD**  
**Do not open the equipment.**

Only qualified personnel should work inside the equipment.

**Immediately turn off the power at the switchboard if water leaks into the equipment or something is dropped in the equipment.**

Continued use of the equipment can cause fire or electrical shock. Contact a FURUNO agent for service.

**Do not disassemble or modify the equipment.**

Fire, electrical shock or serious injury can result.

**Do not place liquid-filled containers on the top of the equipment.**

Fire or electrical shock can result if a liquid spills into the equipment.

**Immediately turn off the power at the switchboard if the equipment is emitting smoke or fire.**

Continued use of the equipment can cause fire or electrical shock. Contact a FURUNO agent for service.

**Make sure no rain or water splash leaks into the equipment.**

Fire or electrical shock can result if water leaks in the equipment.



## WARNING

**Keep heater away from equipment.**

A heater can melt the equipment's power cord, which can cause fire or electrical shock.

**Use the proper fuse.**

Fuse rating is shown on the equipment. Use of a wrong fuse can result in equipment damage.

**Do not operate the equipment with wet hands.**

Electrical shock can result.

**⚠ CAUTION**

**Do not exceed 18 knots when operating the equipment and do not exceed 16 knots when lowering or raising the transducer.**

The transducer may become damaged.

**The zinc block attached near the transducer must be replaced yearly.**

The junction between the transducer and main shaft may corrode, which can result in loss of the transducer or water leakage inside the ship.

**Do not use the equipment for other than its intended purpose.**

Use of the equipment as a stepping stool, for example, may result in personal injury or equipment damage.

**A warning label is attached to the equipment. Do not remove the label. If the label is missing or damaged, contact a FURUNO agent or dealer.**

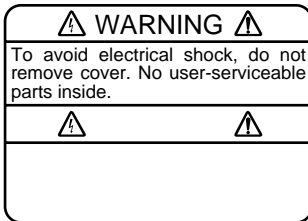

Name: Warning Label (1)  
Type: 86-003-1011-0  
Code No.: 100-236-230

# TABLE OF CONTENTS

---

<b>1. FOREWORD</b>	<b>1</b>
<b>2. SYSTEM CONFIGURATION</b>	<b>2</b>
<b>3. CONTROLS</b>	<b>3</b>
Operating Controls .....	3
Main Panel .....	4
Control Box Panel .....	5
Menu Screen .....	7
<b>4. BASIC OPERATION</b>	<b>10</b>
General .....	10
Turning the Power On/Off .....	10
Lowering the Transducer .....	11
Selecting a Display Range .....	11
Setting the Tilt Angle .....	11
Adjusting the Gain .....	15
<b>5. FINE TUNING THE PICTURE</b>	<b>16</b>
General .....	16
Eliminating Unwanted Feeble Echoes .....	16
Displaying Surface Fish Clearly .....	17
Suppressing Seabed Tail .....	17
Suppressing Seabed and Sea Surface Reflections in Shallow Fishing Grounds .....	18
Rejecting Sonar Interference and Noise .....	18
Selecting Horizontal Beamwidth .....	19
Selecting Vertical Beamwidth .....	19
<b>6. ADVANCED OPERATION</b>	<b>20</b>
General .....	20
Measuring Range and Bearing to a Target .....	20
Detecting Fish Schools Aurally .....	20
Relocating Fish School for Easy Observation .....	21
Finding Fish School Center .....	22
Registering F1/F2 (function) key and Recalling .....	22
<b>7. MARK AND DATA</b>	<b>24</b>
Marks .....	24
Data .....	25
<b>8. INTERPRETING THE DISPLAY</b>	<b>26</b>
General .....	26
Interpreting the Display .....	26

<b>9. WARNING</b>	<b>30</b>
Overvoltage Warning .....	30
Unretracted Transducer Warning .....	30
<b>10. MENU</b>	<b>32</b>
General .....	32
Changing Menu Settings .....	32
<b>11. INTERFACE MODULE CSH-5060</b>	<b>35</b>
Specifications .....	35
Operation .....	36
Indications .....	47
Marks and Data .....	51
Event Mark Position Output .....	52
<b>12. MAINTENANCE</b>	<b>53</b>
General .....	53
<b>13. UNIT DIAGNOSTIC TESTS</b>	<b>54</b>
Description of Unit-diagnostic Tests .....	54
<b>14. CHARACTERISTICS OF THE ULTRASONIC WAVE IN WATER</b>	<b>58</b>
Sound Velocity .....	58
Absorption and Attenuation .....	59
Refraction .....	60
Adverse Effect of Air Bubbles .....	61
Reflection at Seabed and Fish School .....	62
<b>SPECIFICATIONS</b>	<b>SP-1</b>

## INDEX

# 1. FOREWORD

---

The FURUNO CSH-5 MARK-2 Color Scanning Sonar is a full-circle, multibeam electronic scanning sonar which detects and instantaneously displays fish schools and underwater conditions in 16 colors on a 14" non-glare, high resolution CRT screen. Its ease of operation, versatility and compact size make it the perfect match for any class of fishing vessel.

Some of the prominent features of the CSH-5 MARK-2 are as follows;

- Compact 8" tube retraction tank
- Vivid 16-color display greatly improves recognition of seabed, and concentration, distribution and volume of fish schools.
- Various on-screen indications keep operator abreast of fishing conditions.
- Change of control setting is indicated by displaying the new setting in larger characters for five seconds.
- High power MOS FET transmitter ensures reliable operation under any condition.
- Control box, for operation from a distance.

The CSH-5 MARK-2 is a highly sophisticated instrument which performs its intended functions only when operated properly. Please carefully read and follow the recommended procedures for operation and maintenance to take full advantage of the many features this unit has to offer.

## 2. SYSTEM CONFIGURATION

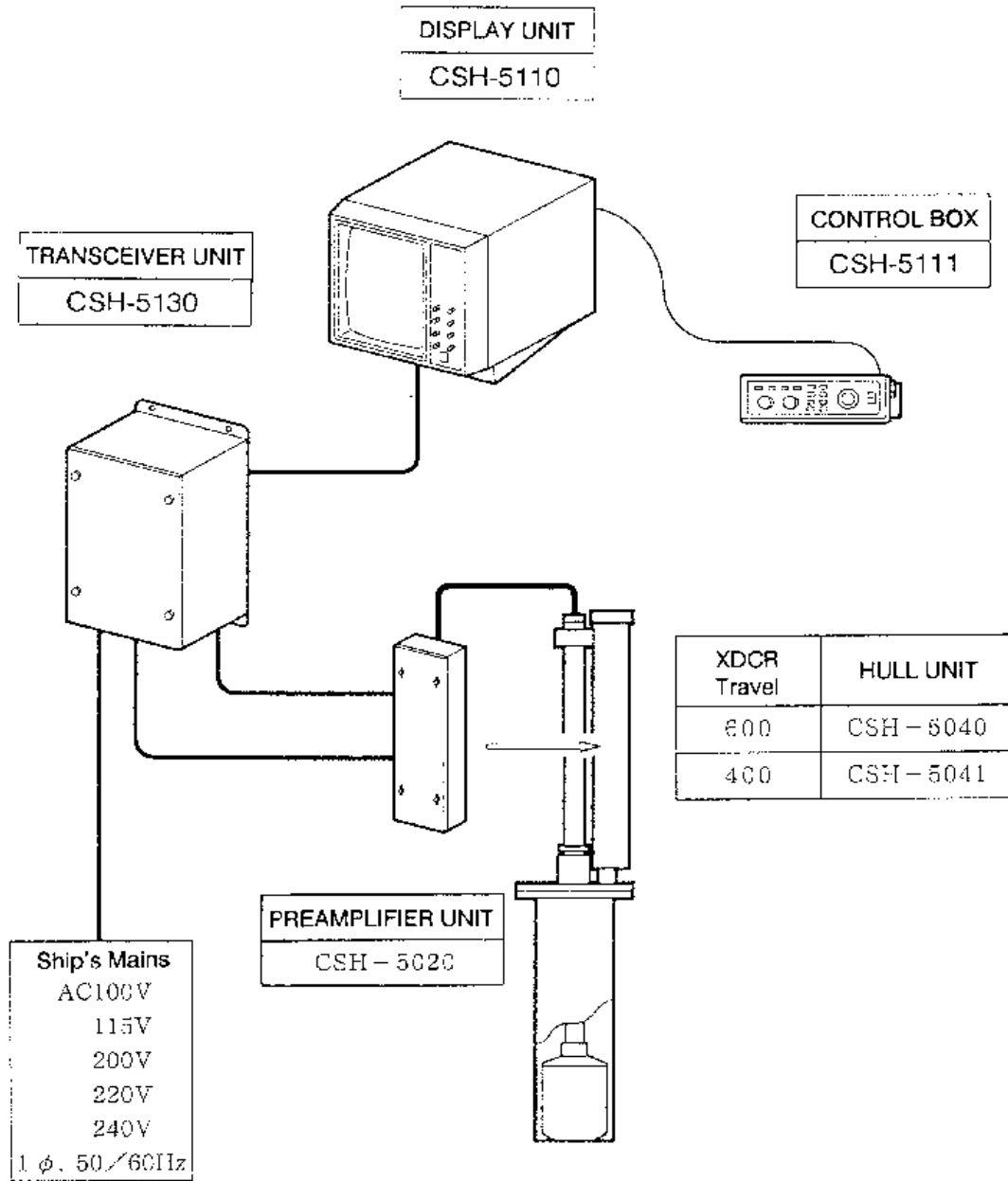

*System Configuration*



# 3. CONTROLS

## Operating Controls

The CSH-5 MARK-2 provides intuitive operation. If you change a control setting you will see the associated reaction on the screen almost immediately. All operations are carried out from the main panel and the control box. The front panel incorporates mainly controls which do not require frequent adjustment, such as brilliance, interference rejector, and audio volume. The control box, which is connected to the display unit via a 7 m-long connection cable, houses the most-often used functions, including transducer operation controls, and range and gain controls.

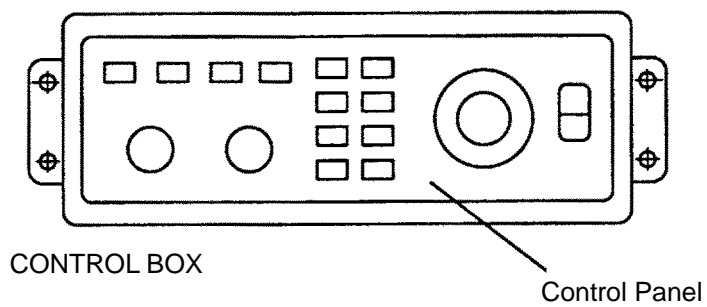
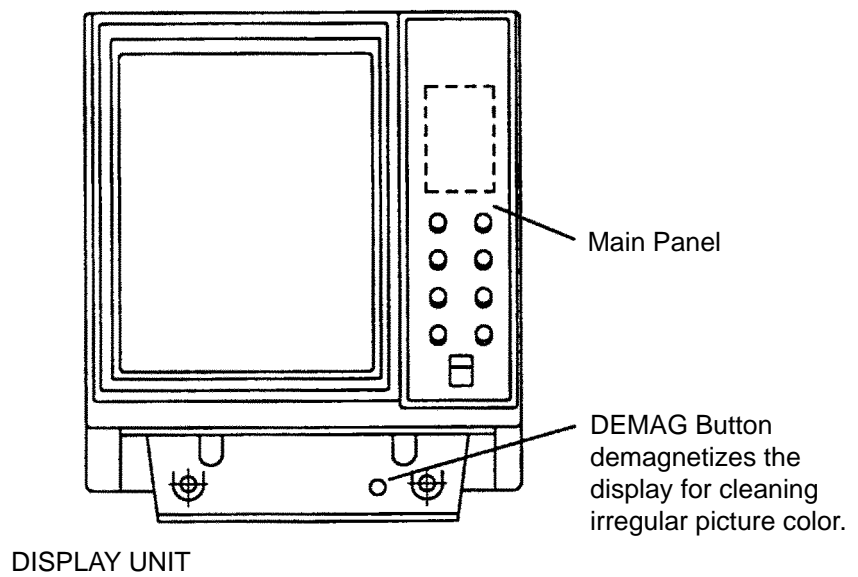

# Main Panel

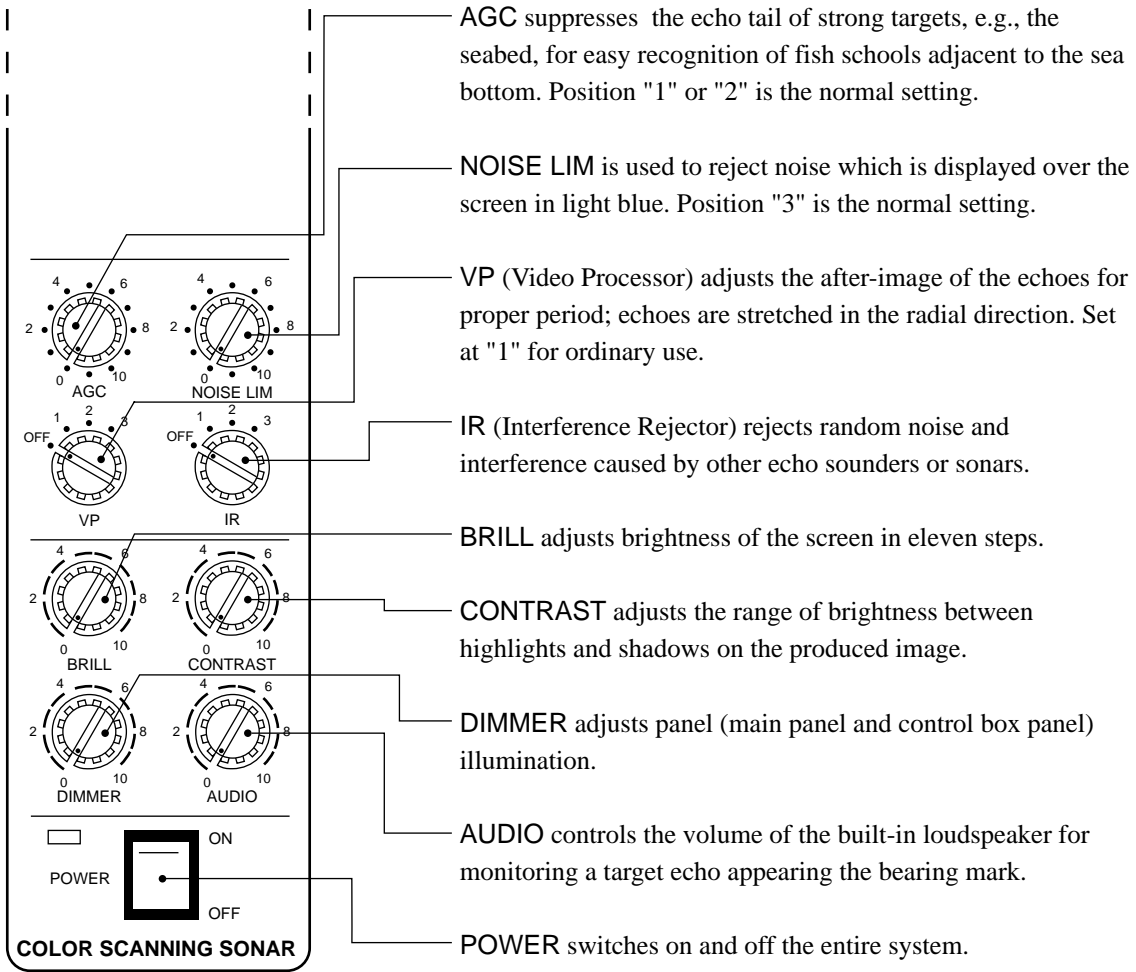

*Note: When the power is turned off before retracting the transducer, the transducer is automatically retracted. However, for safety purposes, do not forget to retract the transducer before turning the power off.*

# Control Box Panel

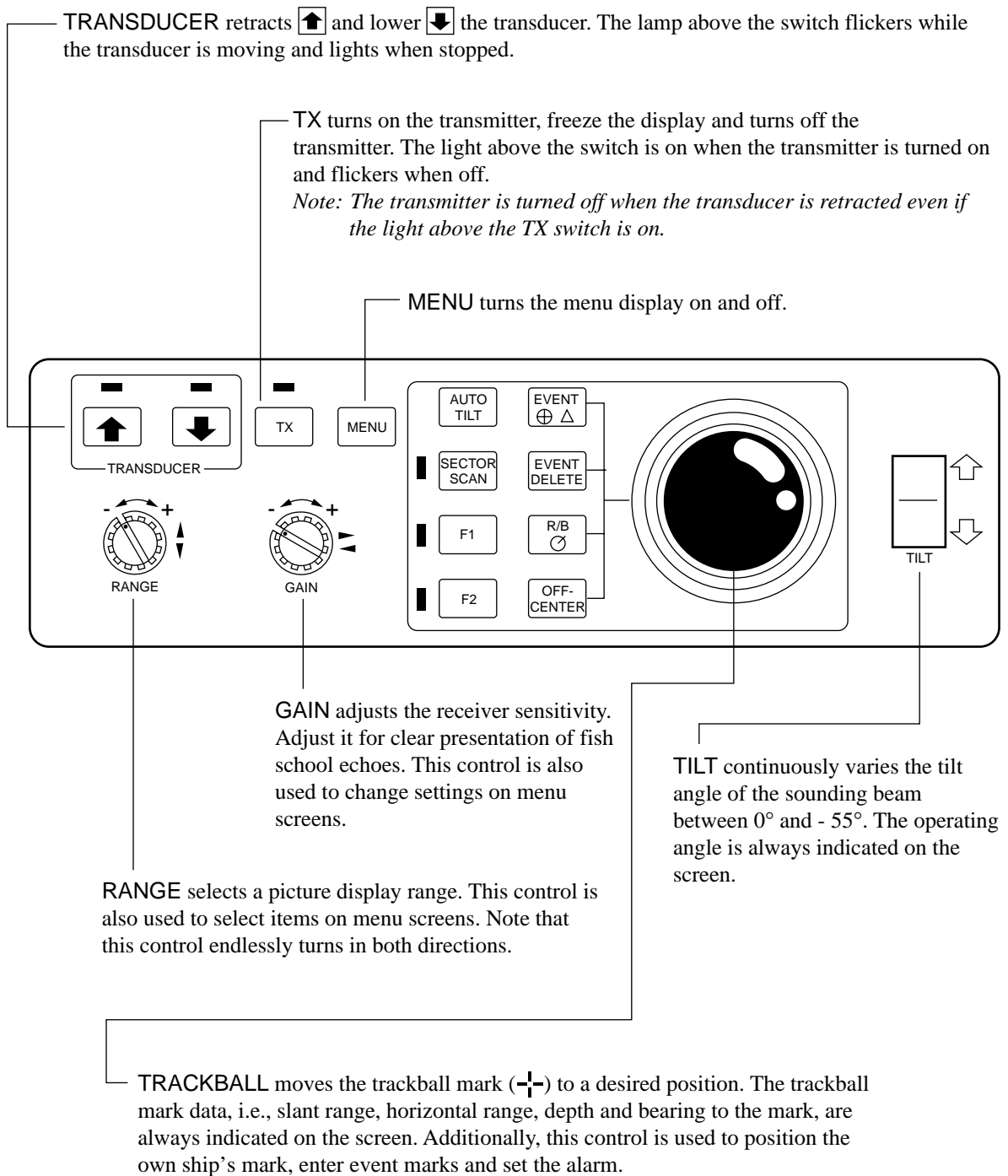



**EVENT** displays the latest event mark “+” and its position data; i.e., horizontal range, depth and bearing measured from own ship’s position. (optional interface board is required to use this function.)



To delete event mark, locate the cursor on a event mark you want to delete and press **EVENT DELETE** key.



**R/B** draws a straight line, called Bearing Mark, from own ship position mark “△” toward the trackball mark “+” and simultaneously draws a circle called Range Mark with a radius of △ to +. Range and bearing data of the intersection of the two marks are displayed on the lower center of the screen. To turn off the range and bearing marks, move the trackball mark near the own ship position mark and press the **R/B** key.



**OFF-CENTER** moves the own ship’s mark to a desired location on the screen in steps of 1/6 of screen radius. To off center the screen, place trackball mark on location to offcenter and press the **OFF-CENTER** key. To reset the off-centered own ship’s mark, press the **OFF-CENTER** key again.



**AUTO TILT** automatically tilts the sounding beam up and down within the tilt angle set on the menu screen.



**SECTOR SCAN** scans the bearing mark in 2° steps within the area selected on the menu screen. The echoes along the marker can be monitored thru the built-in speaker. The lamp at the left of the switch lights during sector scanning.



These keys provide user-defined sonar setting by one key operation. These keys have factory settings. See page 22.

# Menu Screen

The CSH-5 MARK-2 employs four menu screens; menu-1, menu-2 and system menu. Of the four menus, the menu-2 and system menu contain preset items which do not require setting alteration if they are once set at installation. See page 32 for further details. The menu-1 contains items to be set by the operator while using the sonar, taking the fishing ground and fishing method into account. This menu can be recalled on the lower part of the screen as “scan menu” during normal operation. This let you adjust setting while observing the sonar picture.

	Application	How to use
MENU-1	For system setting	After installation, select each item according to your system configuration. Select items after raising the transducer or turning off the transmitter.
MENU-2		
SYSTEM MENU		
SCAN MENU	For user setting	Recall the menu screen by MENU key and adjust the item for the best quality sonar picture.

## Recalling Scan Menu

Press the MENU key, and 5 lines of the menu items are displayed on the lower part of the screen. Note that the scan menu can be recalled only when the transmitter is on.

** SCAN MENU **		( RANGE SW : U/D GAIN SW : L/R )		
HUE	: 1	2	3	4
TX OUTPUT	: 8			
PULSELENGTH	: 7			
TX CYCLE	: 10			
TVG NEAR	: 6			

## Changing Setting

To change a setting, select item with the RANGE control and setting with the GAIN control. The selected item is highlighted in green and the selected setting is circumscribed in white. To scroll the menu items, turn the RANGE control counterclockwise.

*Note: The gain and range of the sonar picture can not be changed while the scan menu is displayed.*

## Turning Off Scan Menu

To turn off the scan menu, press the MENU key.

*Note: Settings for the items shown in red are locked. To unlock the settings, call up the system menu. See page 33.*

## List of Scan Menu Items

** SCAN MENU **		( RANGE SW : U/D GAIN SW : L/R )			
HUE	: 1	2	3	4	
TX OUTPUT	: 8				
PLUSELENGTH	: 7				
TX CYCLE	: 10				
TVG NEAR	: 6				
TVG FAR	: 7				
AUTO SCN WDTN	: ± 10°	± 20°	± 40°	± 60°	
AUTO TLT WDTN	: ± 2°~10°	± 4°~14°	± 6°~20°	± 10°~26°	
HOR BEAM ANGL	: WIDE	NARROW			
VER BEAM ANGL	: WIDE	NARROW			
RES COL CURVE	: LINER	1	2	3	
COL EMPHASIS	: 1 (LOW)	2	3	4 (HIGH)	
FUNC KEY PROG	: FUNC1	FUNC2	FACTORY		

### Contents of Scan Menu

MENU ITEM	MEANING
HUE	Changes the background and foreground colors of the display to compensate for lighting conditions.
TX OUTPUT	Adjusts output power in eleven steps; "0" is for minimum power and "10", maximum. Set to "10" for normal use, and use a low power when sea surface reflection or seabed echo obscures fish schools in short range and shallow water operations. Note that the output power changes 10 seconds after the setting is changed.
PULSELENGTH	Sets a transmission pulselength in eleven steps; "0" is for the shortest length and "10" the longest.
TX CYCLE	Selects transmission repetition rate in eleven steps; "0" is for the longest period and " 10" for the shortest.
TVG NEAR TVG FAR	Control the receiver sensitivity at short and long ranges, respectively. FAR: Over 400 m, position "5" is the normal setting. NEAR: Within 400 m, position "5" is the normal setting.

AUTO SCAN WIDTH	Sets the scan width; $\pm 10$ , $\pm 20$ , $\pm 40$ or $\pm 60$ (in degrees). Use a wide width to conduct a general search of a scan area, narrowing it once a fish school is detected.
AUTO TILT WIDTH	This menu is used to set the automatic tilt width (in degrees); $\pm 2 - \pm 10$ , $\pm 4 - \pm 14$ , $\pm 6 - \pm 20$ , or $\pm 10 - \pm 26$ . The two numbers in each setting shows that the width changes as the range in use changes; left number for the longest range and right one for the shortest range.
HOR BEAM ANGL	This menu is used to select the horizontal beam angle. Select wide for general use; narrow for better bearing discrimination.
VER BEAM ANGL	Sets the vertical beam angle. Select narrow for general use; wide for fish which swims up and down at a high speed. Note that the wide beam angle allows to search a wide area vertically but fish detection range is shortened since the transmitted power spreads. Note also that, when used in a shallow water, the bottom echo is displayed widely.
RES COL CURVE (Response Color Curve)	This menu sets the balance between weak and strong echoes. In the LINEAR position, output (echo strength displayed) varies proportionally with input (actual echo strength). Select a higher setting to better emphasize weak echoes: weak echoes are displayed in stronger echo colors as the number goes higher. The standard setting is LINEAR position.
COLOR EMPHASIS	This menu is used to set the proportion of red in the color display; as the number goes higher, greater proportion echoes are displayed in red.
FUNCKEY PROG	This menu is used to register user-defined setting for F1 and F2 keys. FACTORY is to set default setting.

# 4. BASIC OPERATION

## General

This section provides information necessary for basic operation of the CSH-5 MARK-2, from turning the power on and off to detecting and tracking fish schools. The basic operating procedure is shown below.

### Basic Operating Procedure

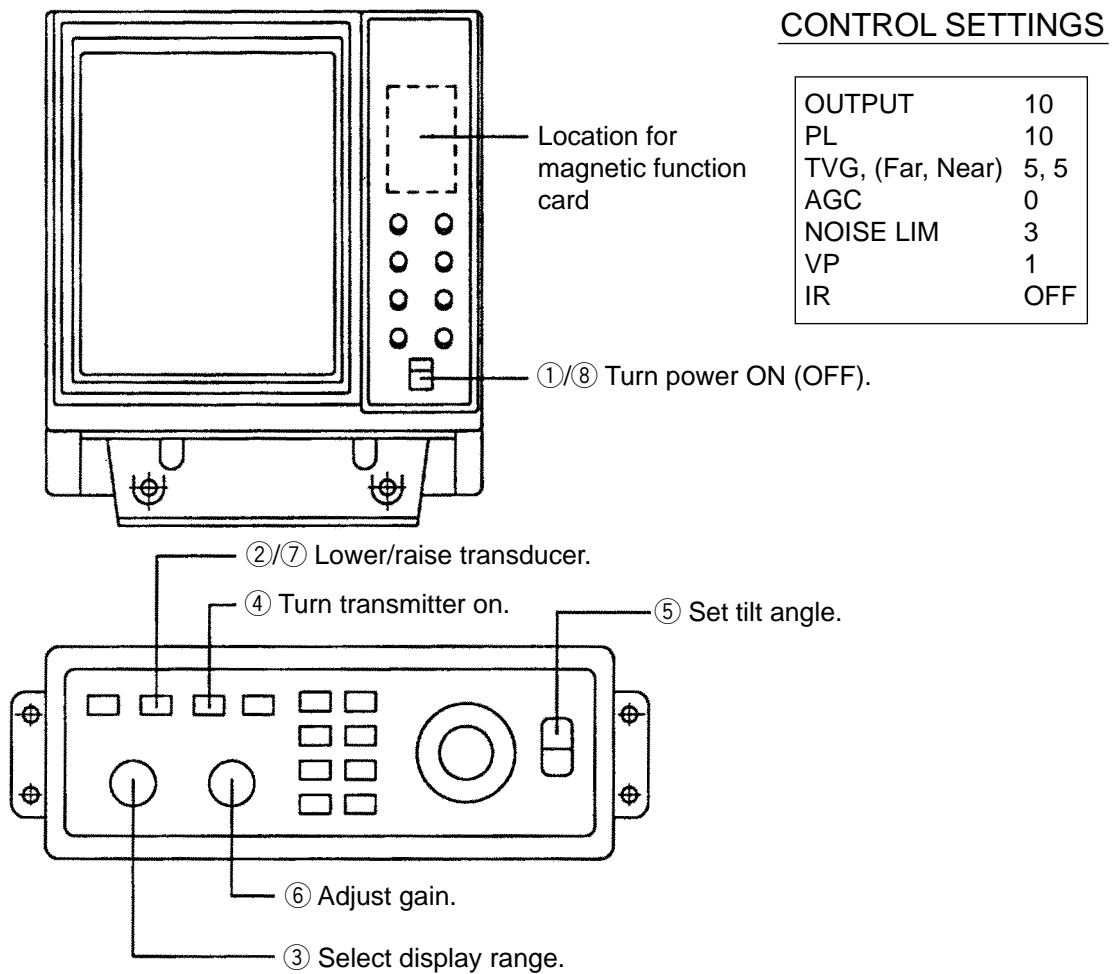

## Turning the Power On/Off

### Power On

Press the POWER switch on the main panel. The lamp at the left of the switch lights.

*Note: The Display and the Transceiver are checked for proper operation each time the power is applied. The check is explained in greater detail in a later chapter.*



## Power Off

Press the TRANSDUCER “↑” switch on the control box. Wait until the lamp above the switch lights, and then press the POWER “OFF” switch. Note that the transducer automatically retracts into the tank even if the POWER “OFF” switch is pressed without raising the transducer (by pressing the TRANSDUCER “↑” switch). However, for safety purposes, it is recommended that you make a habit of pressing the TRANSDUCER “↑” switch first to ensure that the transducer is retracted.

## Lowering the Transducer

Press the TRANSDUCER “↓” switch. The lamp above the switch flickers, and then lights when the transducer is fully lowered.

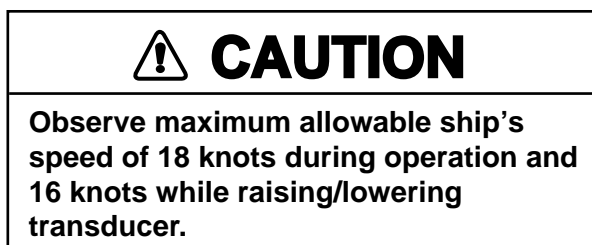

## Selecting a Display Range

The RANGE switch on the control box is used to select a display range. The range selected is displayed at the top center of the screen.

## Setting the Tilt Angle

The tilt angle shows the direction to which the sound wave is emitted. When the sound wave is emitted horizontally, it is said to be zero (0) degrees and when emitted vertically, 90 degrees. To set a tilt angle, operate the TILT lever for the desired angle while watching the tilt angle indication at the top right-hand side of the screen. The tilt angle can be set in one-degree steps within the range of 0 to 55 degrees.

Finding the proper tilt angle is of utmost importance when searching for fish. This unit, because of its compact size, is highly suited to coastal water fishing where the depth of the main fishing ground is from 50-100 m. In this type of fishing ground it is imperative that the seabed echo be always displayed to properly distinguish between fish and the seabed. When selecting a tilt angle, keep the following points in mind.

## Seabed Echo vs Tilt Angle

### Case 1: Tilt Angle 30 to 40 degrees

A wide tilt angle will display the entire seabed since it is captured by the full width of the beam.

### Case 2: Tilt Angle 10 to 20 degrees

A narrow tilt angle will display only half the seabed since it is captured by only the lower half of the beam.

### Case 3: Tilt Angle 0 to 10 degrees

An exceptionally narrow tilt angle may or may not capture the seabed since the returning echo is weak.

## Example of How to Discriminate Fish Echoes from the Seabed

The following figure illustrates how two fish schools (a) and (b) are displayed on screen using three different tilt angles.

### Case 1: Tilt angle 30 to 40 degrees

Fish school is obscured by the seabed.

### Case 2: Tilt angle 10 to 20 degrees

Fish school is located above the seabed (midwater).

### Case 3: Tilt angle 0 to 10 degrees

Fish school is located close to the seabed.

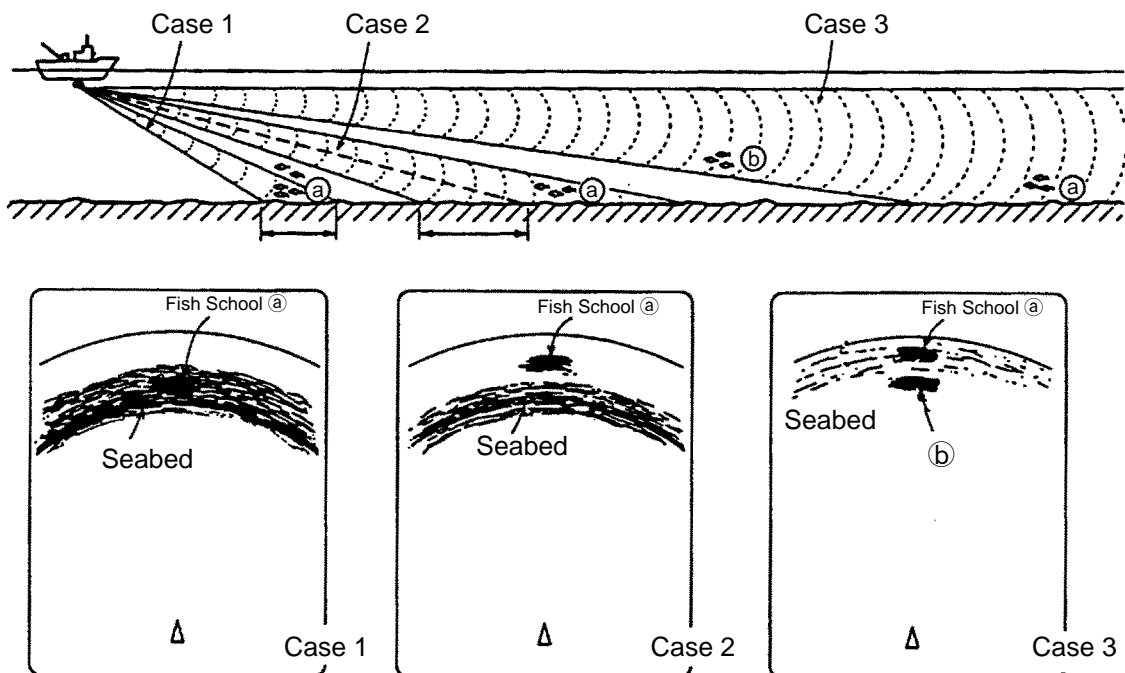

## Points to Consider

- As a general rule of thumb, a vertically distributed fish school is a better sonar target than the seabed, since it reflects the transmitted pulse back toward to the source.
- In case 3, both fish schools (a) and (b) are presented. Generally speaking, however, midwater fish schools tend to be larger than bottom fish schools and they are often displayed near the seabed on the sonar screen.
- Detection of bottom fish is difficult if they are not distributed vertically.

## Tilt Angle for Surface Fish

Sound emitted from the sonar transducer forms a circle-shaped beam with a width of approximately 13 degrees in the vertical direction (vertical beam width). The tilt angle is indicated by the angle between the center line of the beam and the horizontal plane. Then, if the tilt angle is set to 0 degrees, the center line is parallel with the sea surface and one half of the emitted sound goes upward toward the sea surface.

This causes a half of the emitted sound to be reflected back toward the transducer and displayed on the screen as sea surface reflections. When the sea is calm, since the sound is reflected just like a light hitting a mirror at a narrow incident angle, it propagates away and the sea surface reflections become negligible.

However if the sea is not calm enough, they will become dominant and will interfere with observation of wanted echoes. To minimize these sea surface reflections and to search surface fish schools effectively, the tilt angle is usually set to 5-6 degrees so that the upper portion of the beam becomes almost parallel with the sea surface. When the sea is rough, it is often set to a little larger angle.

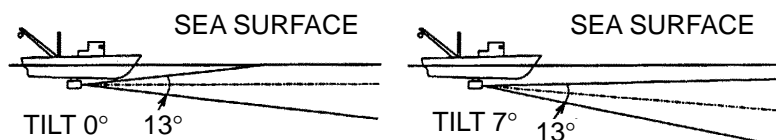

## Suitable Tilt Angle

The figure on the next page illustrates the relationship among tilt angle, depth and detection range. Refer to it to find out the suitable tilt angle for a given depth/detection range.

# TILT ANGLE

Tilt angle vs. Beam Coverage

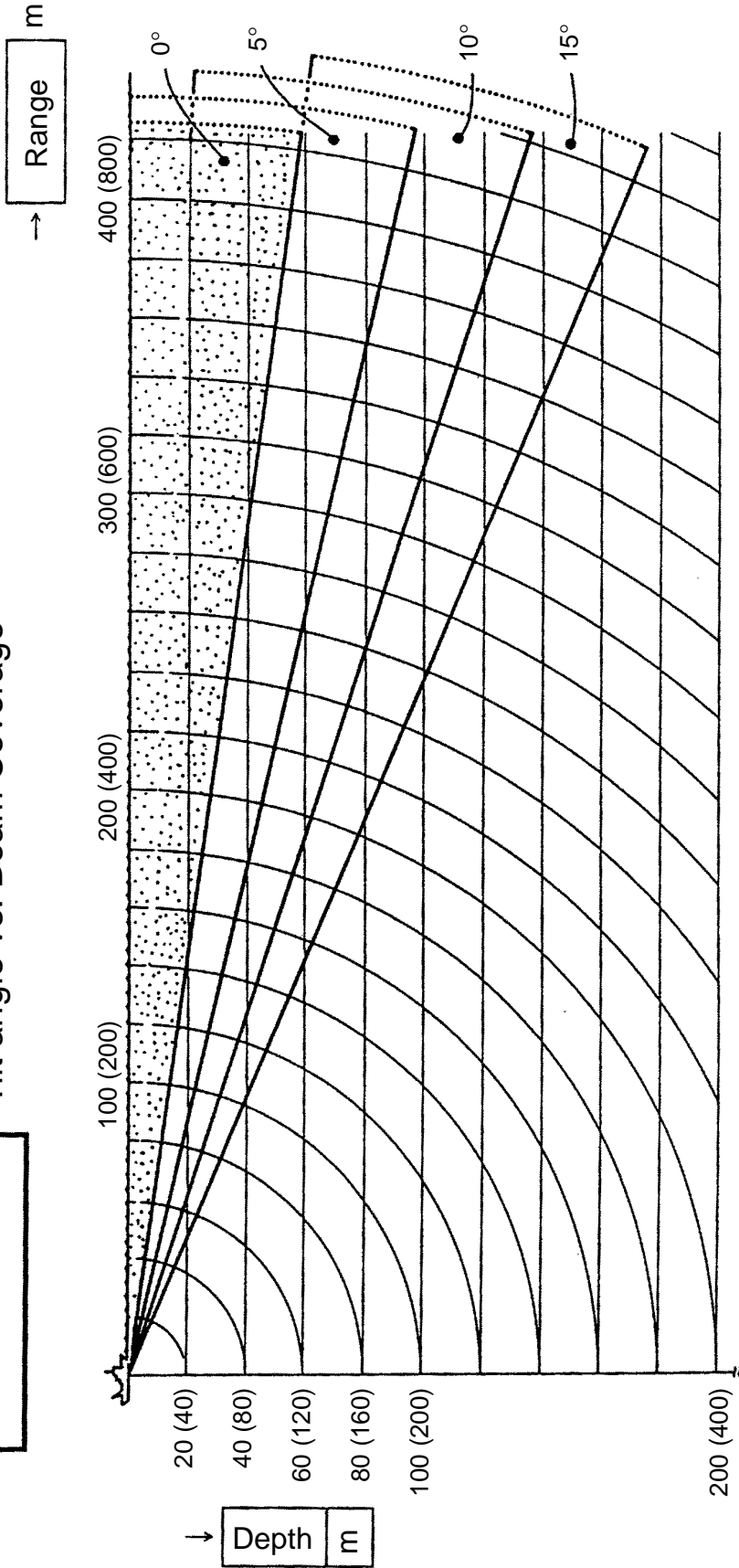

# 【 Vertical Width of Sonar Beam 】

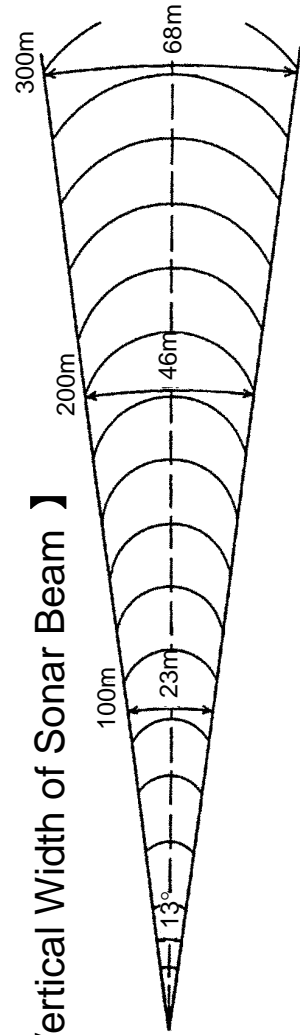

## Adjusting the Gain

The gain should be adjusted to see fish echoes clearly with minimal noise on the screen. Too high a setting not only causes excessive noise on the screen and makes it difficult to discriminate wanted fish echoes but also causes seabed echoes to be painted in strong colors, resulting that the echoes from bottom fish are masked by seabed reflections. Normally, positions “3” thru “7” are used.

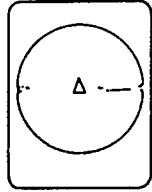

Gain Low



Gain Proper



Gain High

# 5. FINE TUNING THE PICTURE

---

## General

In the previous chapter basic operation of the sonar was presented. This chapter describes the procedures for fine tuning the sonar picture.

## Eliminating Unwanted Feeble Echoes

Echoes from targets such as seabed and fish return to the transducer in order of distance to them, and when we compare their intensities at the transducer face, those from nearer targets are generally stronger when their reflecting properties are nearly equal. The sonar operator will be quite inconvenienced if these echoes are directly displayed on the screen, since he can not judge the actual size of the target from the size of echoes displayed on the screen. To overcome this inconvenience, the TVG function is incorporated. It compensates for propagation loss of sound in water; amplification of echoes on short rang is suppressed and gradually increased as range increases so that similar targets are displayed in the similar intensities irrespective of the ranges to them.

The CSH-5 MARK-2 incorporates two TVG function, NEAR and FAR, and they mainly compensate for propagation loss on short and long ranges respectively, centered at the ranges shown below. Setting a TVG in the scan menu larger (smaller) increases (decreases) amplification of echoes.

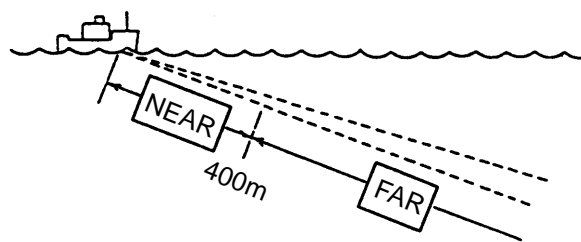

The TVG is also used to suppress unwanted echoes and noise which appear in a certain range area on the screen such as sea surface reflections and cruising noise. To obtain the proper TVG setting, follow the procedure below.

## TVG Setting Procedure

1. Set the TVG menus NEAR to "5" and FAR to "5". These are the standard setting and you can maintain these settings in most cases.
2. When sea surface reflections or plankton layers disturb the picture, adjust the NEAR control to eliminate them. They will be eliminated by decreasing the control setting by "1" or "2".

3. Locate a fish school on a long range setting which is approaching own ship. Note that the tilt should be kept adjusted so that the fish school is always placed in the center of the sonar beam, i.e., so that the fish school is displayed in strongest colors possible. Check that the fish echo is displayed in the same color while it approaches. If the color changes suddenly to weaker colors as the fish echo enters FAR and NEAR areas, the TVG is improperly set. Adjust the TVG in the scan menu to correct it. If this again produces sea surface reflections and noise, try to remove them with the AGC and NL controls as described later on.

## Displaying Surface Fish Clearly

When you are searching for surface fish with the tilt set to a narrow angle, sea surface reflections may disturb or mask wanted fish echoes. In this case, in addition to the TVG adjustment described earlier adjust the AGC control between positions “0” thru “3”.

## Suppressing Seabed Tail

As noted earlier, fish schools (echoes) located near the seabed are sometimes difficult to detect because you have to discriminate them in the seabed reflections. The AGC control and PULSELENGTH in the scan menu, if used properly, decrease the tail of seabed reflections, making it easier to discriminate bottom fish.

### AGC Control

The AGC control functions to automatically reduce the receiver gain only against strong echoes such as the seabed or a large fish school. Since weak echoes remain unaffected, a small fish school becomes easier to detect. Adjust it so that the AGC works only on seabed reflections. Do not turn it too far clockwise.

### PL (Pulselength)

The pulselength control determines the length of the transmission pulse emitted into the water. While a longer pulse is advantageous for long range sounding, it has the disadvantage of being poor in discrimination of targets, i.e., ability to separate several closely located targets. When searching bottom fish, therefore, it is useful to shorten the pulselength in order to separate fish echoes from seabed reflections. Decrease the PL setting to shorten the pulselength in the scan menu. For search of surface and midwater fish in which seabed reflections are not so strong, the longest pulselength “ 10” should be used.

# Suppressing Seabed and Sea Surface Reflections in Shallow Fishing Grounds

In shallow fishing grounds with hard or rocky bottom, seabed reflections often interfere with wanted fish echoes and they can not be eliminated sufficiently with the aforementioned TVG and AGC controls, especially when the TILT is set to a larger angle in order to track fish schools approaching within 400 m. In such cases try to reduce the output power by setting the OUTPUT in the scan menu without turning down the gain. The picture becomes clearer when output power is reduced rather than when the gain is decreased as illustrated below.

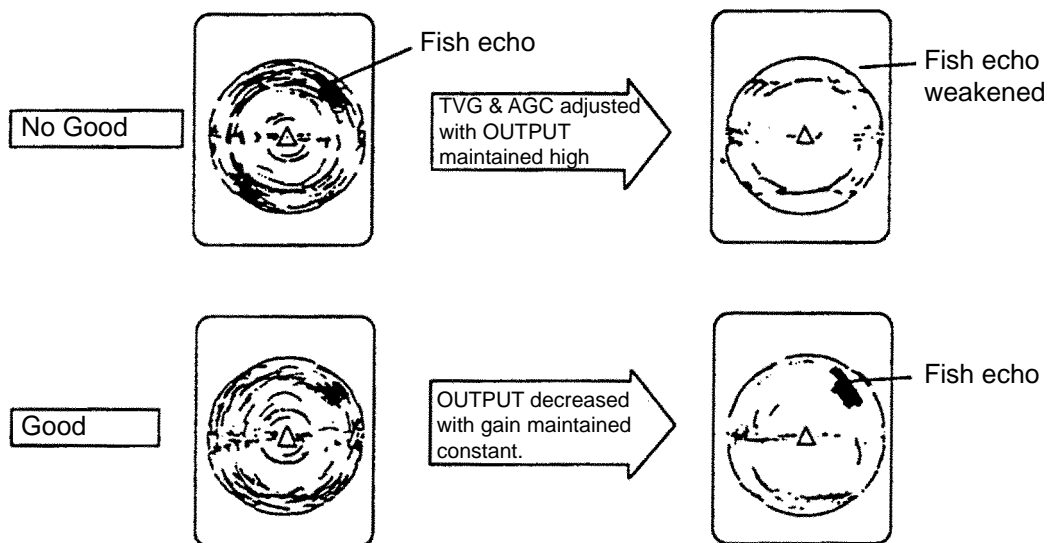

## Rejecting Sonar Interference and Noise

While observing the sonar picture, you may encounter occasional or intermittent noise and interference as shown below. These are mostly caused by on-board electronic equipment, engine or propeller noise, or electrical noise from other sonars being operated nearby.

### Identifying Noise Source

To eliminate noise effectively, you should first identify the noise source.

- \* Turn off the TX switch on the control box and operate all on board equipment one by one while observing the picture.
- \* Run the boat at various speeds to check if the noise is speed dependent.

If neither of the above two steps has effect on the picture, adjust the IR (Interference Rejector) and NOISE LIM (noise limiter) controls as follows.



## Rejecting Noise with IR Control

This control is similar to the interference rejector on echo sounders and radars. It is effective for rejecting random noise and sea surface reflections in rough sea conditions. Set the IR control to positions “1” thru “3” so that noise is just eliminated. Do not use an unnecessarily high setting since it may also reject small wanted echoes.

## Rejecting Noise with NOISE LIM Control

Weak, unwanted reflections, colored light blue or green, are displayed when water is contaminated or plankton layers exist or due to ship’s noise. These echoes gradually become bluish as the NOISE LIM control is turned clockwise. Usually position “3” to “4” is used.

## Rejecting Interference with TX Cycle

When other sonars operate nearby at the same transmission interval as that of own ship’s sonar, interference ring caused by other sonars are displayed. To erase the interference ring from the screen, reduce the TX cycle setting on the scan menu screen. See page 8.

*Note: When the sonar is used in a shallow water with the range set between 100 m and 200 m and the TX cycle at “10”, seabed reflections caused by the transmission which is the last but one on near range on screen. Reduce the figure of TX cycle to “7” or “8” to reject them.*

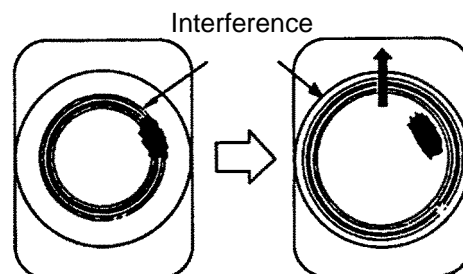

## Selecting Horizontal Beamwidth

If you wish to have better bearing discrimination\* for fish schools and also wish to examine the contour of seabed, call up scan menu and select “narrow horizontal beam width”.

\* Ability to distinguish two closely located targets at the same range and different bearings.

## Selecting Vertical Beamwidth

When better detection range is required, call up scan menu and select “narrow vertical beamwidth”.

# 6. ADVANCED OPERATION

## General

In this section, how to use the CSH-5 MARK-2 effectively in actual fishing operations is presented.

## Measuring Range and Bearing to a Target

To measure the range and bearing to a target, use the trackball.

### Procedure

1. Operate the trackball to place the trackball mark “+” on the target you want to measure the range and bearing. The range and bearing are displayed at the left top on the screen.

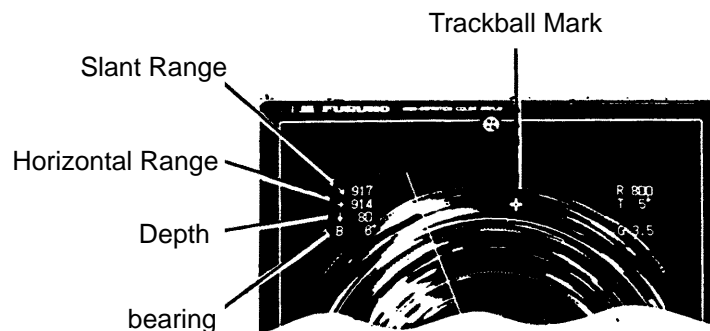

*Note: The bearing is shown in either 360° or 180° indication system relative to the ship's heading. In the latter case, “B” is indicated as follows.*

B □ □ □ P ----- on the port side  
B □ □ □ S ----- on the starboard side

The 360° or 180° indication system can be selected on the menu-2. See page 33.

## Detecting Fish Schools Aurally

Occasionally you will be preoccupied with other tasks and unable to concentrate on watching the sonar picture. In such cases it would be a good choice to use the audio function. This function enables you to monitor echoes from fish schools and seabed through the built-in speaker.

After you become accustomed to utilizing the audio function, you should be able to detect a fish school from a range longer than you can detect it on the screen.

## Procedure

1. Move the trackball mark “+” to the direction you want to monitor through the speaker, by operating the trackball.
2. Press the R/B key. The bearing marker will appear in the direction of the trackball mark and echoes in that direction are monitored through the speaker. Adjust the volume with the AUDIO control on the front panel.

**To cover a certain area**, press the SECTOR SCAN key. The bearing marker automatically scans in 2° steps starting from the bearing set at step 2 to cover the selected sector, giving you audio in the directions of 2° steps.

**To change the coverage area call up scan menu**, and then select an auto scan width with the GAIN control; ±10°, ±20°, ±40°, ±60°.

**To turn off the audio function**, erase the bearing marker by placing the trackball mark on own ship mark and then pressing the R/B key.

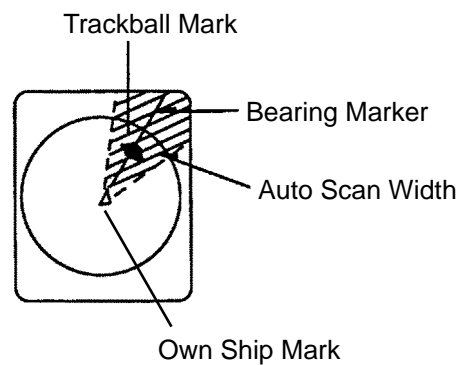

## Relocating Fish School for Easy Observation

When a fish school is located near the edge of the screen and inconvenient for observation, use the off-center function to relocate the fish school to the desired place on the screen.

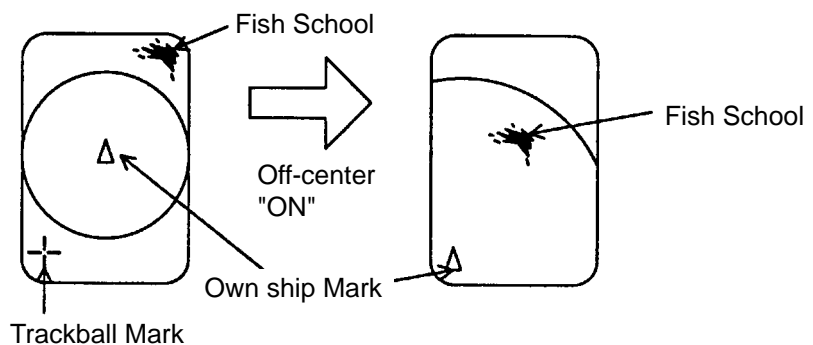

## Procedure

1. Move the trackball mark “+” to the position where the own ship mark is to be moved.

2. Press the OFF-CENTER key on the front panel.
3. To move the own ship mark back to the center of the screen, press the OFF-CENTER key again.

## Finding Fish School Center

When you want to find the center depth of a fish school, use the auto tilt function which automatically scans the tilt angle within the selected width.

### Procedure

1. Call up the scan menu, select the menu item "AUTO TLT WDTN" and then choose a tilting width. The center tilt angle of the scanning is set by the TILT lever.

Both center and current tilt angles are displayed along with the range data at the upper right corner on the screen.



## Registering F1/F2 (function) key and Recalling

Function keys provide user defined sonar settings by one key operation.

### Default setting

These keys are preset at factory for one key operation as follows;

F1 : For detection of near range		F2 : For detection of far range	
TX OUTPUT	8	TX OUTPUT	10
PULSELENGTH	7	PULSELENGTH	10
TX CYCLE	10	TX CYCLE	10
TVG NEAR	6	TVG NEAR	5
TVG FAR	6	TVG FAR	8
HOR BEAM ANGLE	NARROW	HOR BEAM ANGLE	NARROW
VER BEAM ANGLE	WIDE	VER BEAM ANGLE	NARROW
RES COL CURVE	3	RES COL CURVE	LINEAR
COL EMPHASIS	2	COL EMPHASIS	4

(Factory setting)

Three magnetic function cards are supplied for indication of function settings. Two of these cards are inscribed with the factory setting of F1 and F2. The other card is blank for recording user settings. You can attach the card on the main panel for reference. See page 10.

## Registering Procedure

1. Press the MENU key.
2. Rotate the RANGE control to select FUNC KEY PROG.
3. Rotate the GAIN control to select FUNC1 or FUNC2.
4. Press the TX key. Each time the TX key is pressed, the current settings in the scan menu and E/S menu are recorded.

When FACTORY is selected, the default value is displayed.

## Recalling Procedure

1. Press F1 or F2. Presetting function is recalled and function indication (LED lamp) lights.

## Canceling the recalling

1. Press F1 or F2 again. The LED lamp goes off.

## Recommended Settings

We recommend the function key be set as follows,

### For detection of surface fish school

TX OUTPUT	8
PULSELENGTH	7
TX CYCLE	10
TVG NEAR	5
TVG FAR	5
HOR BEAM ANGLE	NARROW
VER BEAM ANGLE	NARROW
RES COL CURVE	LINEAR
COL EMPHASIS	3

### For detection of bottom fish

TX OUTPUT	7
PULSELENGTH	5
TX CYCLE	10
TVG NEAR	5
TVG FAR	6
HOR BEAM ANGLE	NARROW
VER BEAM ANGLE	WIDE
RES COL CURVE	3
COL EMPHASIS	1

### For detection of midwater fish

TX OUTPUT	8
PULSELENGTH	8
TX CYCLE	10
TVG NEAR	6
TVG FAR	7
HOR BEAM ANGLE	NARROW
VER BEAM ANGLE	WIDE
RES COL CURVE	2
COL EMPHASIS	3

# 7. MARK AND DATA

This chapter describes the marks and data which appear on the display screen.

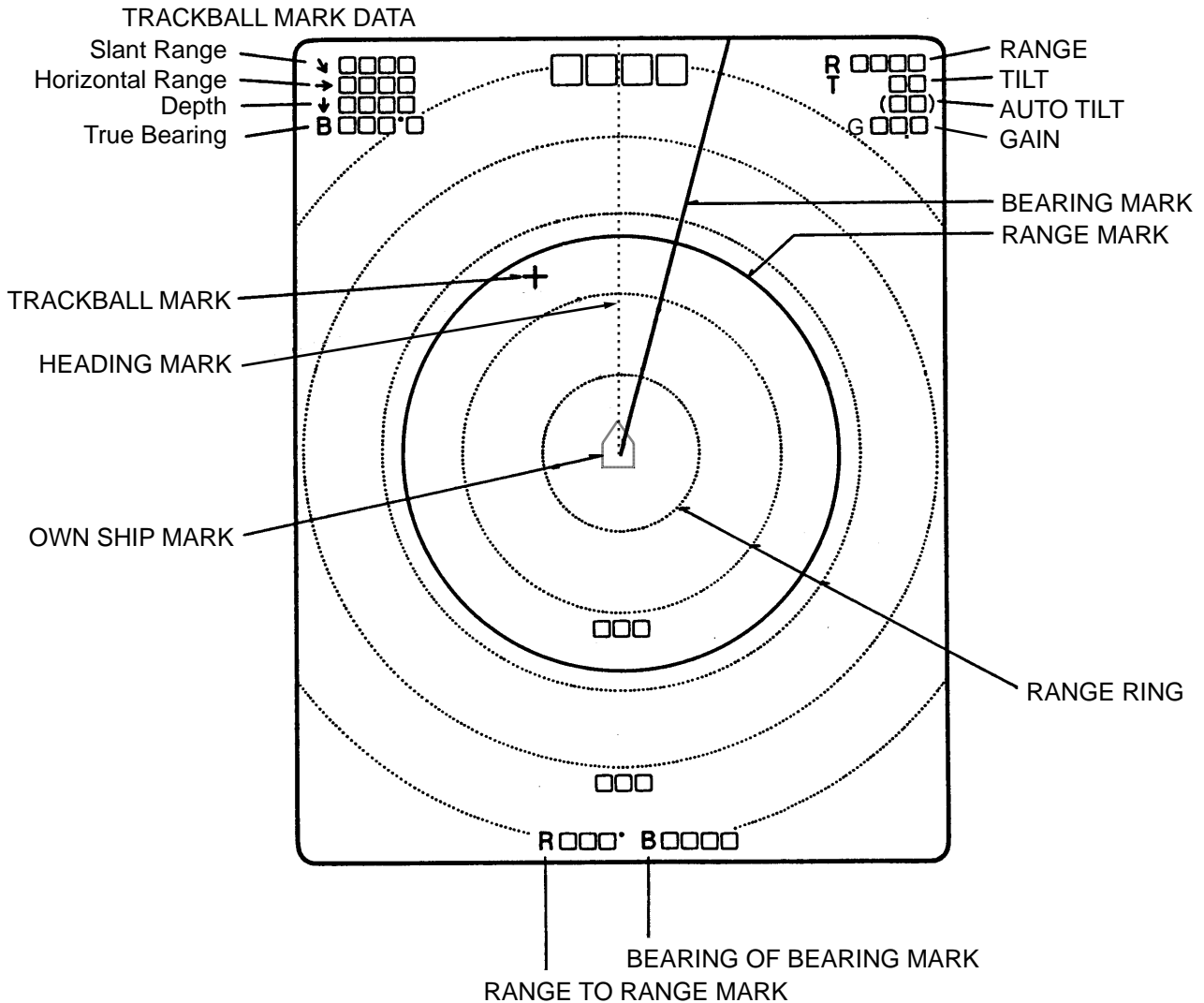

## Marks

Own Ship Mark	Shows ship's position on the screen. The mark points in the direction of ship's heading.
Trackball Mark	The trackball mark " + " selects location of marks and an own ship's position. The trackball moves this mark anywhere over the entire screen.
Heading Mark	The ship's heading mark is drawn with a dotted line. When the range ring is turned off by changing the setting on scan menu, the heading mark is also turned off.

Range Ring	The range rings are plotted at intervals of 1/4 of the range in use. Range ring data are also provided every two range rings. The range ring interval can be altered from 1/4 to 1/2 of the range in use by changing the appropriate setting on scan menu.
Range/Bearing Marks	The range and bearing marks are displayed when the R/B key is pressed and the bearing mark scans in a few degree steps when the SECTOR SCAN key is pressed, giving audio in that direction. To stop the scanning of the bearing mark, press the SECTOR SCAN key again. The two marks are erased when the R/B key is pressed after placing the trackball mark on own ship mark.

## Data

Trackball Data ↘ □□□□ → □□□□ ↓ □□□□ B □□□°	↘ : Slant Range → : Horizontal Range ↓ : Depth B : Bearing The bearing is shown in either 360° or ± 180° indication system relative to ship's heading. In the latter case, "B" is indicated as follows. B □□□ P ----- on the port side B □□□ S ----- on the starboard side																
Range Data R □□□□	Shows the range scale set with the RANGE switch.																
Tilt Data T □□° ( □□ )	The tilt angle set with the TILT level is displayed in 1° steps between 0° and 55°. When the auto tilt function is in operation, instantaneously changing present tilt angle is indicated below it; ( □□ ).																
Gain Data G □□.□	The gain set with the GAIN control is displayed in 0.5 steps between 0 and 10.																
Range/Bearing Mark Data B □□□□ R □□□°	The slant range to the range marker and the bearing of the bearing mark is displayed.																
Setting Change Data	When the setting of the following switches is changed, the new setting is noted in larger characters for about five seconds at the top of the screen. The current tilt angle and sector range are also displayed upon switching on the AUTO TILT switch. <table border="1" style="margin-left: auto; margin-right: auto;"> <thead> <tr> <th>Switches</th> <th>Display</th> <th>Switches</th> <th>Display</th> </tr> </thead> <tbody> <tr> <td>TILT</td> <td>T □□°</td> <td>AUTO TILT SPD</td> <td>± □□°</td> </tr> <tr> <td>GAIN</td> <td>G □□.□</td> <td>AUTO SCAN WPTH</td> <td>± □□°</td> </tr> <tr> <td>RANGE</td> <td>R □□□□</td> <td></td> <td></td> </tr> </tbody> </table>	Switches	Display	Switches	Display	TILT	T □□°	AUTO TILT SPD	± □□°	GAIN	G □□.□	AUTO SCAN WPTH	± □□°	RANGE	R □□□□		
Switches	Display	Switches	Display														
TILT	T □□°	AUTO TILT SPD	± □□°														
GAIN	G □□.□	AUTO SCAN WPTH	± □□°														
RANGE	R □□□□																

# 8. INTERPRETING THE DISPLAY

## General

This section provides information necessary for interpreting the display.

## Interpreting the Display

### Seabed

When the tilt angle is changed, the seabed echo illustrated below will appear on the screen. When the tilt angle is decreased, the seabed trace becomes wider and weaker. By observing the seabed condition on the screen, the skipper can prevent the net from being damaged by a reef or a shipwreck.

(a) Flat Seabed

Tilt Angle:  $10^{\circ}$  -  $15^{\circ}$

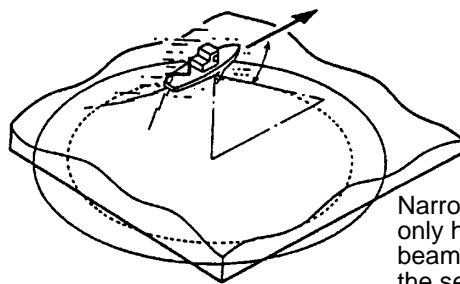

Seabed Echo

Narrow tilt angle; only half of vertical beam width captures the seabed.

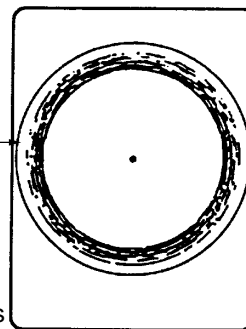

(b) Flat Seabed

Tilt Angle:  $20^{\circ}$  or more

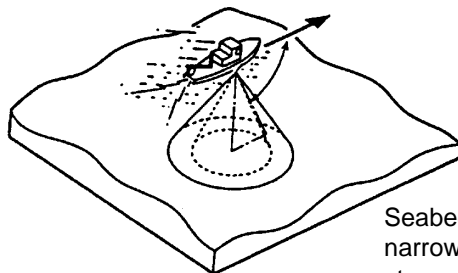

Seabed Echo

Seabed is displayed narrower and in a stronger echo colors compared to (a).

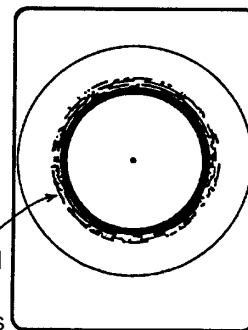

(c) Slanting Seabed

Tilt Angle:  $20^{\circ}$  or more

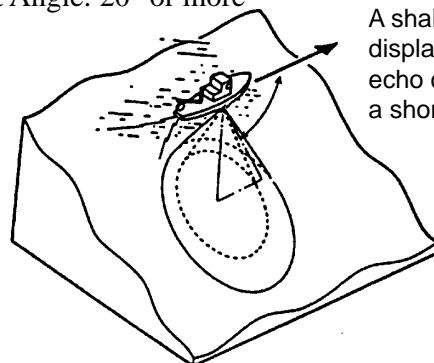

A shallow bottom is displayed in a strong echo color and with a short tail.

Seabed

The deeper seabed echo is displayed in a weak color and with a long tail.

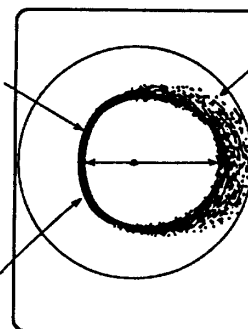



# Fish School

A fish school appears as a mass of echoes on the screen. The color of the mass shows the density of fish schools on the sonar beam. To know the distribution and center point of a fish school, the tilt should be changed to several different angles.

(a) Sea Surface Fish

Tilt Angle:  $+5^{\circ}$  -  $10^{\circ}$

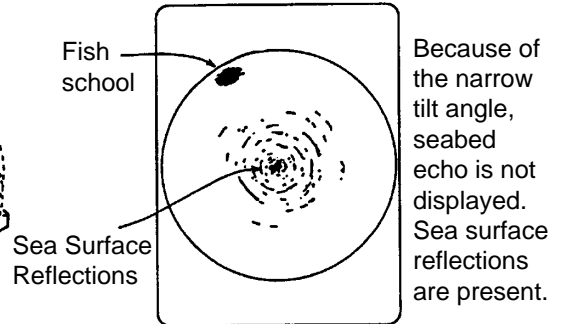
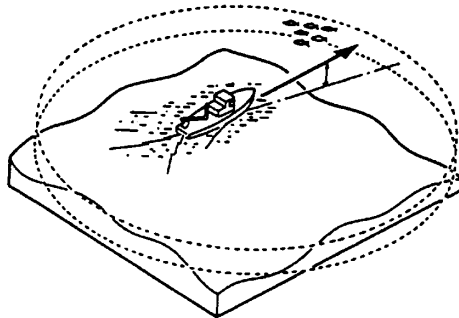

(b) Midwater, Bottom Fish

Fish echo appears before seabed echo

Tilt Angle:  $30^{\circ}$  or more

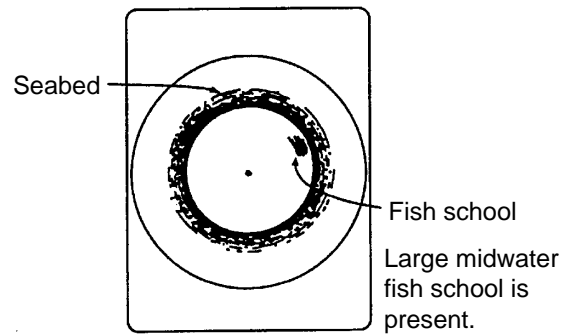
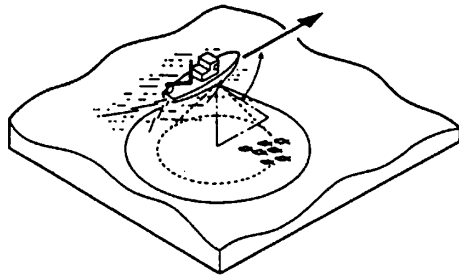

Fish echo appears together with or after seabed echo

Tilt Angle:  $0^{\circ}$  -  $20^{\circ}$

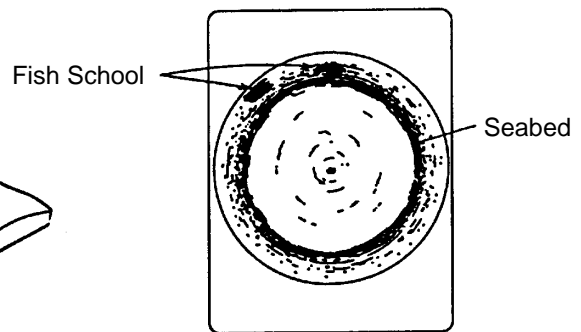
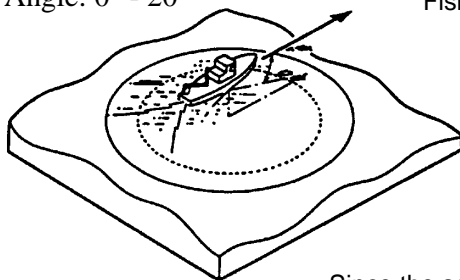

Since the seabed is displayed in weak echo colors, longer range detection and detection of close to bottom fish school become possible.

## Sea Surface Reflections

To reduce the sea surface reflections, set the tilt angle to  $5^\circ$  or more so that the upper edge of the sonar beam may not hit sea surface, or adjust TVG functions. When the sonar is used with a narrow tilt angle, the sea surface reflections cover large area (up to 300 m to 400 m) as illustrated below.

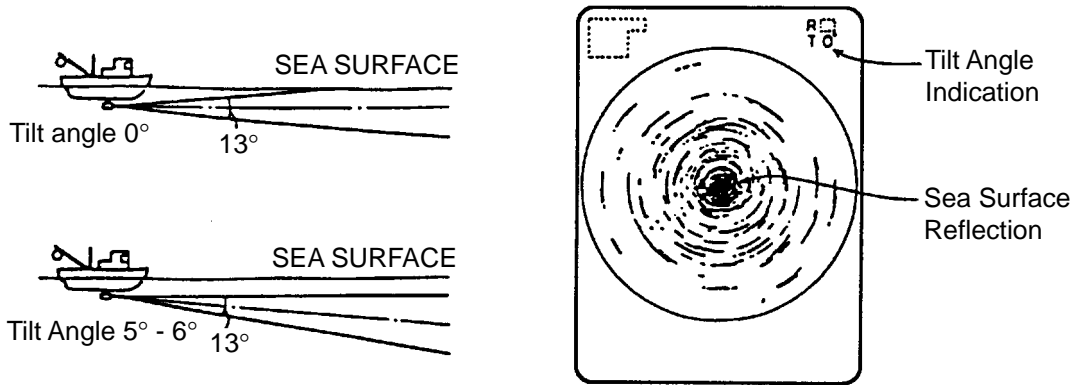

## Wake

Wake produced by own ship or another ship can be a strong reflecting object when the sonar is used with a narrow tilt angle. As the wake appears on the screen as a thick continuous line, it can be easily distinguished from a fish school. On the other hand, the wake contains a lot of air bubbles which attenuate ultrasonic energy, making it often difficult to sound beyond the wake.

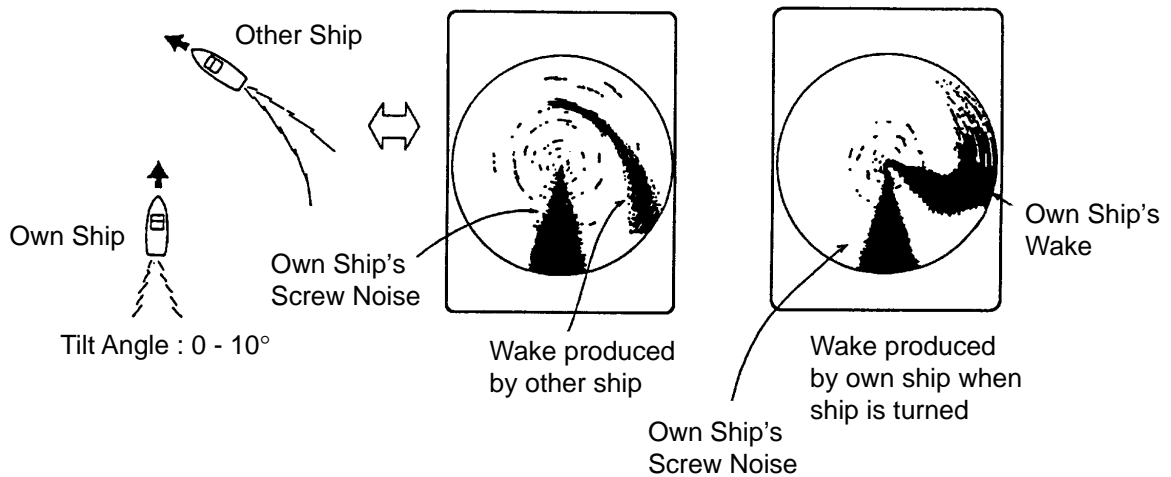

## False Echo by Sidelobe

In the preceding chapters, it was explained that an ultrasonic wave is emitted only in the direction set by the TILT lever, but, in practice, there are some emissions outside the main beam that are called “sidelobes”. Energy of the sidelobe is fairly weak but when the sonar is used in comparatively shallow water with a hard and rocky bottom, strong target signals are detected by the sidelobe. These are represented on the screen as a false echo as shown below. To weaken the sidelobe echoes, set the VER BEAM ANGLE to WIDE on the SCAN MENU.

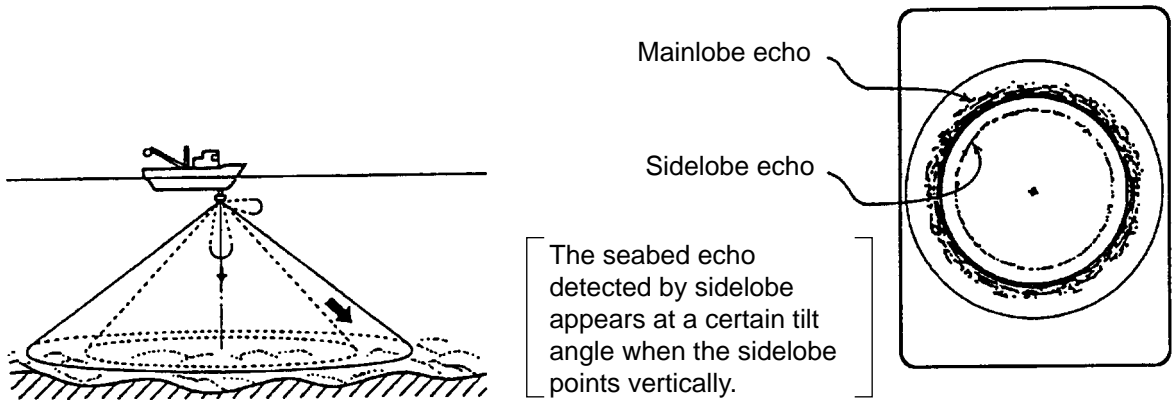

## Noise and Interference

In case the fishing ground is crowded with many fishing boats, the sonar is subject to interference from ultrasonic equipment such as an echo sounder, sonar, etc. on board other boats as well as those on board own ship.

For instance, interference from the sonar operated on board other boats will appear as a ring as shown in (A). This interference can be suppressed by properly changing TX cycle. Electrical equipment on own ship can also cause interference to the sonar as shown in (B). The noise from some marine life appears on the screen as in (C). This noise can be suppressed by the IR control.

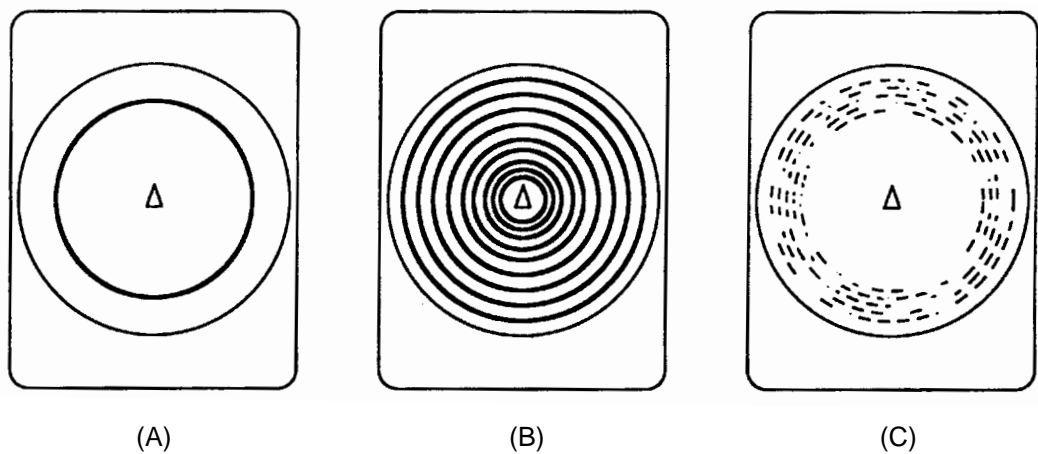

Noise and Interference

## 9. WARNING

---

### Overvoltage Warning

If the supply voltage rises about 20% to over the rated value, the overvoltage detection circuit is actuated. The following warning flickers at the center of the screen and an alarm sounds.

#### **OVERVOLTAGE!**

If this occurs, retract the transducer, turn the POWER off and check the ship's mains (and the stepdown transformer if provided).

### Unretracted Transducer Warning

When the transducer can not be completely retracted within 35 seconds after pressing the TRANSDUCER “” switch, the following warning flickers at the center of the screen and an alarm is released.

#### **XDCR NOT RETRACTED!**

If this occurs, do the following.

1. The POWER switch can not be turned off because the transducer can not be retracted. Turn off the main breaker for the transceiver unit to stop operation.
2. Confirm that the net is not entwined around the transducer.
3. Confirm that the breaker inside the raise/lower control box mounted on the hull unit is “ON”.
4. Check the mains fuse in the transceiver unit.
5. Apply the power again and confirm that the transducer is retracted into the tank. If not, the main shaft of the hull unit may be bent. Cut off the power again and manually raise the transducer up to the highest position by using the hand crank attached to the hull unit.

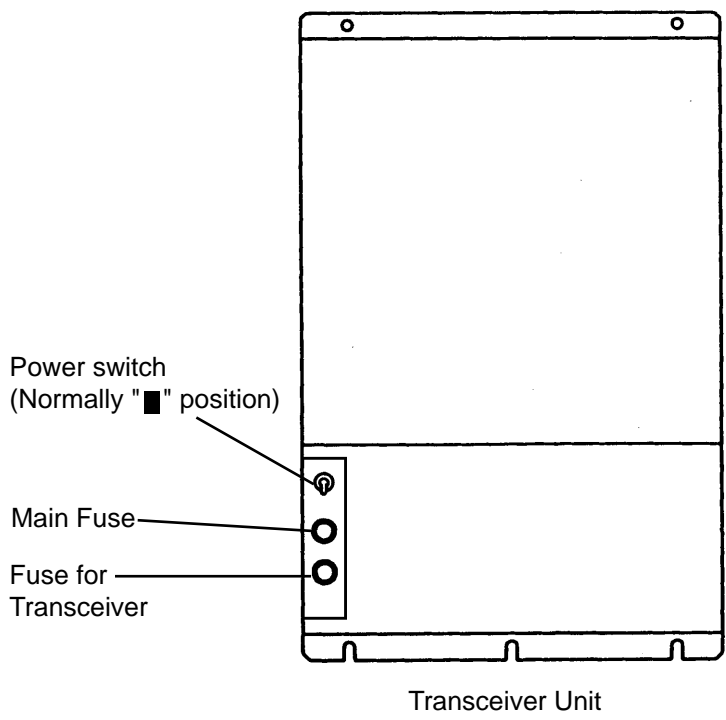
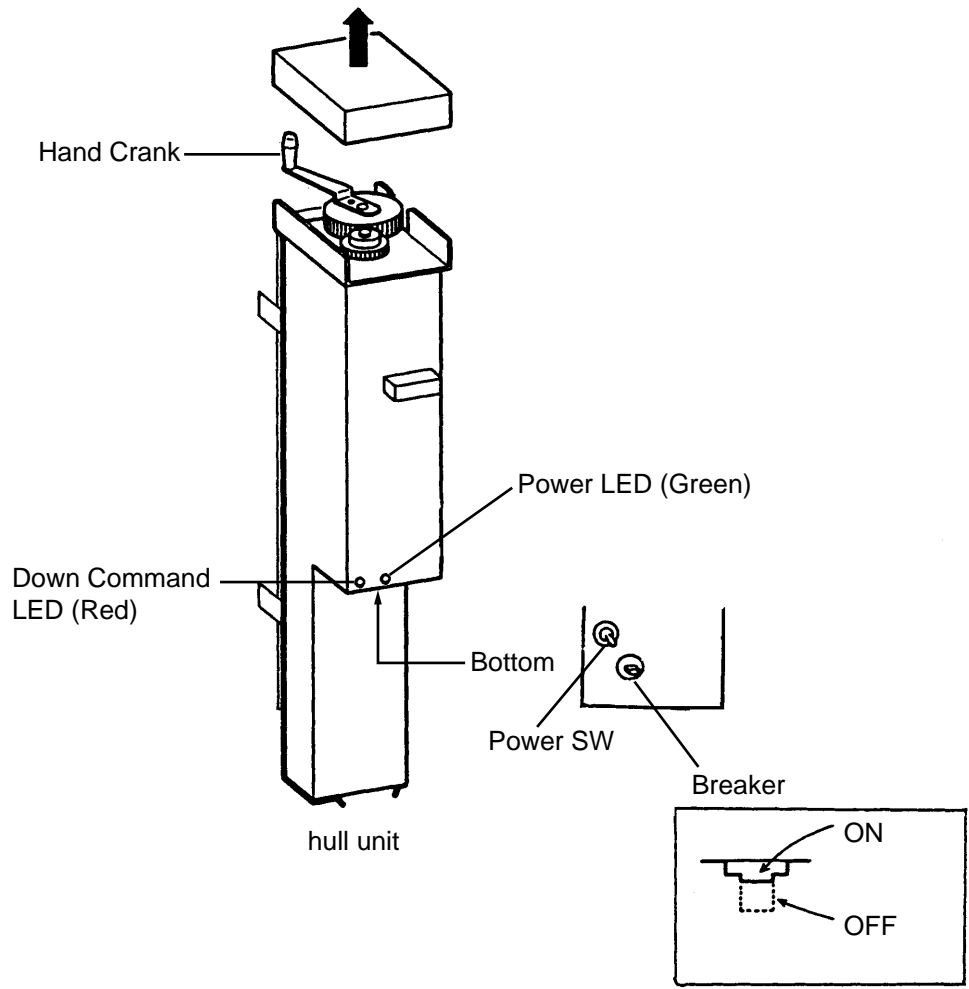

## General

The CSH-5 MARK-2 employs three menu screens, menu-1 menu-2, and system menu, to preset infrequently used functions.

## Changing Menu Settings

### Procedure to Change Menu Settings

1. Turn off the transmitter with the TX key; LED flickers.
2. Press the MENU key. The menu-1 appears.
3. To select another menu, operate the GAIN control.
4. Select a menu item with the RANGE switch and change the setting with the GAIN control.

*Note: Setting for the items shown in red are locked. To unlock the settings, change the "menu select" setting on the system menu.*

### Menu-1

The figure below shows menu-1.

The contents of the menu-1 are same as the scan menu described on page 8.

** SCAN MENU **		( RANGE SW : U/D GAIN SW : L/R)			
[MENU MODE]	:	<b>MENU-1</b>	MENU-2	SYSTEM	
HUE	:	<b>1</b>	2	3	4
<b>TX OUTPUT</b>	:	8			
PULSELENGTH	:	7			
TX CYCLE	:	10			
TVG NEAR	:	6			
TVG FAR	:	7			
AUTO SCN WDT	:	±10°	<b>±20°</b>	±40°	±60°
AUTO TLT WDT	:	±2~10°	±4~14°	<b>±6~20°</b>	±10~26°
HOR BEAM ANGL	:	WIDE	<b>NARROW</b>		
VER BEAM ANGL	:	<b>WIDE</b>	NARROW		
RES COL CURVE	:	LINEAR	1	<b>2</b>	3
COL EMPHASIS	:	1 (LOW)	2	<b>3</b>	4 (HIGH)
FUNC KEY PROG	:	<b>FUNC1</b>	FUNC2	FACTORY	

## Menu-2

The figure below shows menu-2.

** MENU 2 **			
<b>MENU MODE</b>	:	MENU-1	<b>MENU-2</b> SYSTEM
EXT KP		<b>OFF</b> ON	
RANGE MARKER		<b>1/4R</b> 1/2R	OFF
MARK INDI		<b>±180°</b> 360°	

MENU	MEANING
MENU MODE	Selects a menu: menu-1. menu-2. system menu.
EXTernal Keying Pulse	If two or more echosounders/sonars are operated simultaneously, mutual interference may result due to asynchronous keying pulse output. This menu is used to synchronize keying pulses/turn off synchronization.
RANGE MARKER	This menu selects the number of range rings to be displayed/turns the range rings off.
MARK INDI	Selects +180° or 360° bearing indication.

## System Menu

The figure below shows the system menu.

** SYSTEM MENU **		( RANGE SW : U/D GAIN SW : L/R)			
[MENU MODE]	:	MENU-1	MENU-2	<b>SYSTEM</b>	
-----					
HEADING ADJ	:	0°			
<b>AUTO SCN SPD</b>	:	<b>LOW</b>	HIGH		
AUTO TLT SPD	:	<b>LOW</b>	HIGH		
UNIT	:	<b>METERS</b>	FEET	FATHOMS	PA/BRA
MENU SELECT	:	<b>LOCK</b>	UNLOCK		
SUB TEXT INDI	:	<b>OFF</b>	ON		
LANGUAGE	:	<b>ENGLISH</b>	(JAPANESE)	ESPAÑOL	DANSK
SELF TEST	:	SINGLE	PANEL	COLOR	GRAY
		CONTI	SIO	ECHO-1	ECHO-2

MENU ITEM	MEANING
MENU MODE	Selects a menu; menu-1, menu-2, system menu.
HEADING ADJ	This menu is used to compensate for hull unit misalignment, which results in heading error. Set the actual heading by operating the GAIN control so that the own ship's wake is displayed in 180° direction on the screen.
AUTO SCAN SPD	Selects the scan speed of bearing marker; high or low. High speed scan is useful for general fish searching and tracking fast moving fish schools.
AUTO TILT SPD	Sets the speed of change of the tilt angle for the automatic tilt function.
UNIT	Selects the unit of depth measurement; meter, feet, fathom or passi/braza.
MENU SELECT	This menu enables/disables alteration of menu settings. "Locked" settings are displayed in red.
SUB TEXT INDICATION	This menu turns the sub text indication, which is used by the service technician, on and off. Normally, turn the indication off.
LANGUAGE	Selects the language to be used: Japanese, English, Spanish or Danish.
SELF TEST	This menu is comprised of eight unit diagnostic tests. For further details, see the chapter on maintenance.



# 11. INTERFACE MODULE CSH-5060

## Specifications

The CSH-5060 Interface Module permits connection of external equipment (navigational equipment, current indicator, echo sounder, net sonde, gyrocompass, log, etc.) to display various data on the CSH-5 MARK-2.

### 1. Display Mode

- (a) Normal
- (b) Normal + Text
- (c) Echo Sounder Combination (Normal + Echo Sounder)
- (d) Sonar Combination (Normal + Signal on R/B Mark)

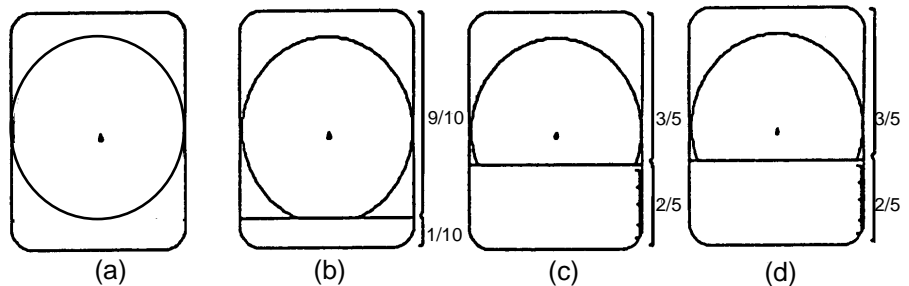

### 2. Display Mark

Course line mark, Current mark, Event mark, Electronic bearing scale, Heading mark, and Net sonde data are graphically displayed on the Echo Sounder Combination mode.

### 3. Numeric Information

- Event Mark Data (Horizontal range, Depth, Latest event marked depth and Bearing)
- Navigational Data (Ship's speed, Heading, Water depth, Temperature)
- Position Data (Latitude, Longitude)
- Tidal Current Data (Speed, Direction)

# Operation

The functions of the Interface Module are accessed from the MENU screen except the Event mark and North mark\*.

\* —Gyrocompass required.

## 1. Event Mark and Own Ship Mark

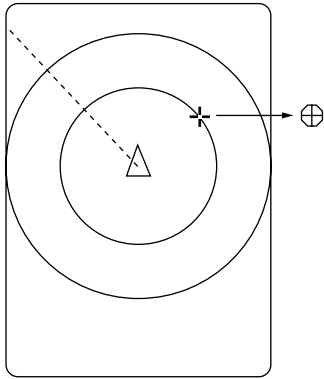

### Plotting

- (1) Move the cursor to the location where you want to plot the event mark.
- (2) Press the EVENT key. The cursor is replaced with the latest event mark [⊕] and the event mark data (horizontal distance, depth and bearing) appears on the lower left side of the screen.

*Note:1. You can plot 10 event marks. (latest mark - ⊕, other 9 marks --- +)*

*2. You cannot plot the event mark at the own ship mark. In this case, the own ship mark is plotted (max.10).*

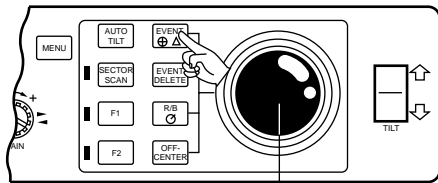

TRACKBALL

### Erasing

Locate the cursor on the event mark and press the EVENT DELETE key.

## 2. Target Lock Mark

Use this mark when you want to track fish echoes automatically.

### Plotting

- (1) Select "TARGET" on the range/bearing item on the SCAN Menu to activate the mark.
- (2) Move the cursor onto the fish echo you want to track.
- (3) Press the R/B key. The bearing mark and the target lock mark appear and start to track the fish echo.

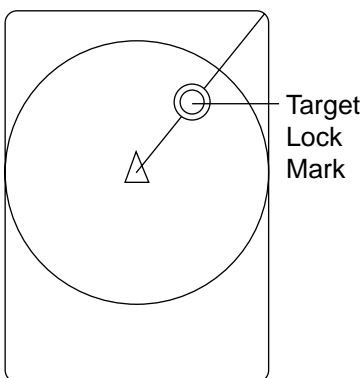

Target Lock Mark

### Erasing

To exit from the tracking mode, press the R/B key again.

*NOTE: When using the target (lock) mode the auto tilt and sector scan controls do not function.*

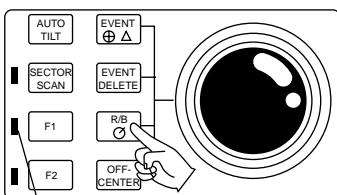

LED lamp

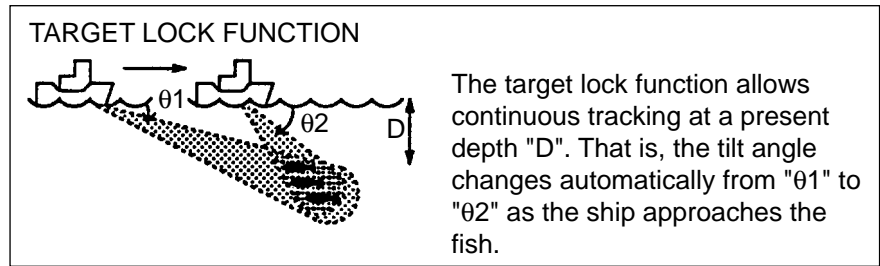

### 3. Erasing Weak Noise

Unknown weak noise appearing over the entire screen can be erased with DELETE COLOR, on the SCAN menu. Echoes are erased in order from weakest to strongest, so you may use this function to show only strong echoes.

1. Press the [MENU] key to turn on the menu.
2. Select DELETE COLOR with the RANGE control.
3. Use the GAIN switch to select desired setting. The setting range is 0-10. "0" turns off this function, 10 erases the strongest color echoes. Note that the echoes on the echo sounder and range and bearing mark display will also be erased.
4. Press the [MENU] key to close the menu.

## 4. Suppressing Effects of Pitching and Rolling

The Motion Sensor MS-100 (option) compensates for the effects of pitching and rolling to provide stable sonar pictures. You may enable it as follows:

1. Press the [MENU] key to display the SCAN menu.
2. Use the RANGE control to select RANGE/BEARING.
3. Use the GAIN control to select STAB.
4. Press the [MENU] key to close the menu.
5. Operate the trackball to place the trackball mark on the bearing you want to compensate by the MS-100.
6. Press the [R/B] key. A dashed line appears at the bearing selected at step 5. The rolling and pitching of the ship in the direction of the bearing mark is compensated, by automatically adjusting the tilt angle.

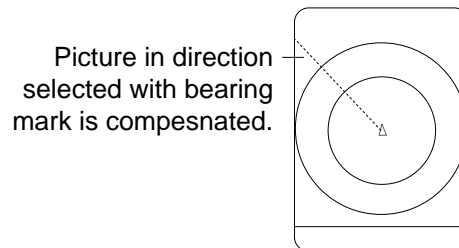

*Note: The entire picture is not compensated in the full-circle scanning; the tilt angle for each bearing cannot be changed. Only one bearing is compensated and bearing error will result for any bearing not stabilized.*

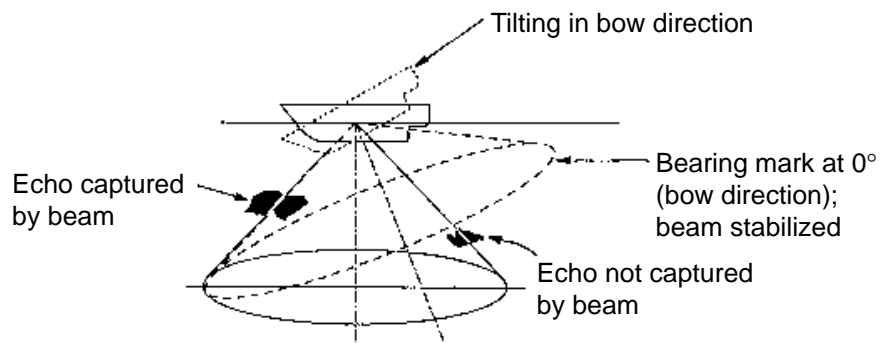

Tilt can be controlled manually from 0° to 55°, however rolling and pitching are compensated from -5° to 55° with the tilt angle at  $\pm 20^\circ$ .

## 5. Detecting Fish Echoes in Specific Area (Fish Alarm)

The fish alarm alerts you to fish echoes in an area you select. Any fish echoes entering the area will trigger the audio alarm. The fish echo level which triggers the alarm may be selected from the scan menu.

1. Press the [MENU] key to open the SCAN menu.
2. On the scan menu, use the RANGE control to select RANGE/BEARING.
3. Use the GAIN control to select FISH/ALM.
4. Use the RANGE control to select FISH ALARM.
5. Use the GAIN control to select ON.
6. Press the [MENU] key to close the menu.
7. Use the trackball to place the trackball mark on the starting bearing and press the [R/B] key.
8. Use the trackball to place the trackball mark on the ending bearing and press the [R/B] key.

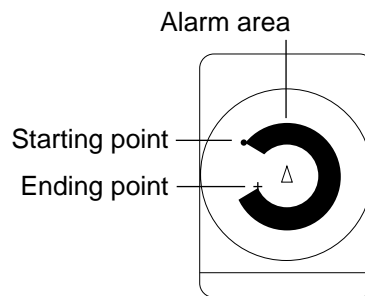

To disable the fish alarm, press the [R/B] key.

*Note: The starting point may be selected at the outside or inside of the alarm zone. You may also set a 360-degree alarm by setting the starting and ending points within three degrees of each other as in (c) and (d) in the figure below.*

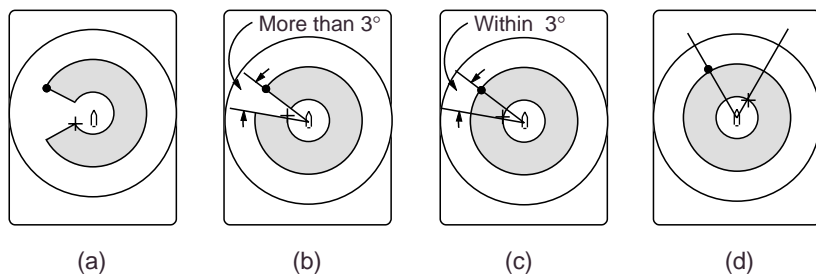

## 6. Fish Alarm On/Off, Fish Alarm Sensitivity

The audio alarm for the fish alarm can be enabled/disabled and the fish alarm sensitivity can be selected from the scan menu.

1. Press the [MENU] key to open the SCAN menu.
2. Use the RANGE control to select FISH ALARM.
3. Use the GAIN control to select the echo strength which will trigger the fish alarm. The setting range is 0 to 14. Choose "0" for no audio alarm. For example, selecting "4" will trigger the audio alarm when an echo whose strength is between 0 and 4 comes into the fish alarm zone.
4. Press the [MENU] key to close the menu.

## 7. Menu Screen

### Recalling

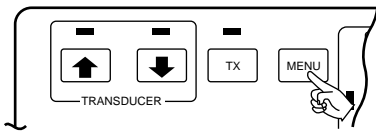

Press the MENU key. The SCAN MENU or E/S\* MENU appears on the lower part of the screen. Note that the SCAN or E/S MENU can be recalled only when the transmitter is ON.

\*--When the Echo sounder combination mode is selected.

### Changing Setting

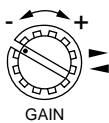

To change a setting, select item with the RANGE control and setting with the GAIN control. The selected item is highlighted in green and the selected setting is circumscribed in white. To scroll the menu, turn the RANGE control counterclockwise.

*Note: The gain and range of the sonar picture can not be changed while the scan menu is displayed.*

### Exit from Menu Screen

To exit from the menu screen and return to the sonar screen, press the MENU key.

*Note: Items shown in RED indicate they are locked to prevent alteration. To unlock a setting, call up the SYSTEM MENU.*

## 8. Menu Description

The CSH-5 MARK-2 employs three menu screens, MENU-1, MENU-2 and SYSTEM Menu, to preset infrequently used functions. During normal operation (transducer lowered, transmitter ON), the SCAN Menu appears on the screen. This lets you adjust settings while observing the sonar picture.

	Application	How to use
MENU-1	For system setting	After installation, select each item according to your system configuration.
MENU-2		
SYSTEM MENU		
SCAN MENU	For user setting	Recall the menu screen by MENU key and adjust the item for the best quality sonar picture.
E/S MENU		

## 9. Menu Screen Indications

### MENU-1

** MENU-1 **		( RANGE SW : U/D GAIN SW : L/R )			
[MENU MODE]	:	MENU-1	MENU-2	SYSTEM	
DISPLAY MODE	:	COMBI 1	NORM	TEXT	COMBI 2
HUE	:	1	2	3	4
TX OUTPUT	:	8			
PULSELENGTH	:	7			
TX CYCLE	:	10			
TVG NEAR	:	6			
TVG FAR	:	7			
AUTO SCN WDTH	:	±10°	±20°	±40°	±60°
AUTO TLT WDTH	:	±2~10°	±4~14°	±6~20°	±10~26°
HOR BEAM ANGL	:	WIDE	NARROW		
VER BEAM ANGL	:	WIDE	NARROW		
RES COL CURVE	:	LINEAR	1	2	3
COL EMPHASIS	:	1 (LOW)	2	3	4 (HIGH)
FUNC KEY PROG	:	FUNC1	FUNC2	FACTORY	
E/S RANGE	:	240			
E/S SHIFT	:	0			
E/S IR	:	ON	OFF		
E/S GAIN	:	3.0			
E/S CLUTTER	:	2.0			
E/S ADVANCE	:	1/1	1/2	1/4	1/8
E/S COL CURVE	:	LINEAR	1	2	3
E/S DRAFT	:	0.0 (m)			

○ : indicates the items which may be locked.

☆ : indicates the menu items available with the addition of the CSH-5060 and external equipment.

## MENU-2

** MENU-2 **		( RANGE SW : U/D GAIN SW : L/R )			
[MENU MODE]	: MENU-1	<b>MENU-2</b>	<b>SYSTEM</b>		
EXT KP SYNC	: <b>OFF</b>	ON			
RANGE MARKER	: <b>1/4R</b>	1/2R	OFF		
BEARING SCALE	: <b>ON</b>	OFF			
CURRENT MARK	: <b>ON</b>	OFF			
COURSE MARK	: <b>10R</b>	5R	OFF		
<b>HEADING INDI</b>	: <b>32-AZI</b>	TRUE			
CURRENT INDI	: <b>32-AZI</b>	TRUE	±180°	360°	
EVENT INDI	: <b>32-AZI</b>	TRUE	±180°	360°	
MARK INDI	: <b>±180°</b>	360°			
POSITION DATA	: <b>L/L</b>	TD			

- 
- 
- ☆
- ☆
- ☆
- ☆
- 
- ☆

## SYSTEM MENU

** SYSTEM MENU **		( RANGE SW : U/D GAIN SW : L/R )			
[MENU MODE]	: MENU-1	MENU-2	<b>SYSTEM</b>		
HEADING ADJ	: 0°				
<b>AUTO SCN SPD</b>	: <b>LOW</b>	HIGH			
AUTO TLT SPD	: <b>LOW</b>	HIGH			
UNIT	: <b>METERS</b>	FEET	FATHOMS	PA/BRA	
SHIP'S SPD/BR	: <b>LOG/GY</b>	CI	NAV		
LOG PULSE	: <b>200</b>	400			
CI BAUD RATE	: <b>4800</b>	2400	1200		
NAV FORMAT	: <b>CIF</b>	NMEA183	NMEA182		
NAV BAUD RATE	: <b>4800</b>	2400	1200		
NAV DATA	: GPS	<b>LC</b>	DEC	DR	
	LA	ALL			
COMBI SCALE	: <b>RIGHT</b>	LEFT			
MENU SELECT	: <b>LOCK</b>	UNLOCK			
SUB TEXT INDI	: <b>OFF</b>	ON			
LANGUAGE	: <b>ENGLISH</b>	(JAPANESE)	ESPAÑOL	DANSK	
SELF TEST	: SINGLE	PANEL	COLOR	GRAY	
	CONTI	SIO	ECHO-1	ECHO-2	

- 
- 
- 
- 
- 
- 
- 
- 
- 
- 
-



## SCAN MENU

** SCAN MENU **		( RANGE SW : U/D GAIN SW : L/R )			
MENU MODE	: SCAN	E/S			
DISPLAY MODE	: COMBI-1	NORM	TEXT	COMBI-2	☆
HUE	: 1	2	3	4	
TX OUTPUT	: 8				○
PULSELENGTH	: 7				○
TX CYCLE	: 10				
TVG NEAR	: 6				
TVG FAR	: 7				
DELETE COLOR	: 0				☆
AUTO SCN WDTH	: ±10°	±20°	±40°	±60°	☆
AUTO TLT WDTH	: ±2~10°	±4~14°	±6~20°	±10~26°	☆
MARK ERASE	: COURSE	SHIP	EVENT		☆
RANGE/BEARING	: NORMAL	TARGET	STAB.	FISH/ALM	☆
FISH ALARM	: ON	OFF			
ALARM LEVEL	: 9				
HOR BEAM ANGL	: WIDE	NARROW			○
VER BEAM ANGL	: WIDE	NARROW			○
RES COL CURVE	: LINEAR	1	2	3	○
COL EMPHASIS	: 1 (LOW)	2	3	4 (HIGH)	○
FUNC KEY PROG	: FUNC1	FUNC2	FACTORY		○

## E/S MENU

** E/S MENU **		( RANGE SW : U/D GAIN SW : L/R )			
MENU MODE	: SCAN	E/S			☆
HUE	: 1	2	3	4	☆
E/S RANGE	: 320				☆
E/S SHIFT	: 0				☆
E/S IR	: ON	OFF			☆
E/S GAIN	: 3.0				☆
E/S CLUTTER	: 1.0				○ ☆
E/S ADVANCE	: 1/1	1/2	1/4	1/8	○ ☆
E/S COL CURVE	: LINEAR	1	2	3	○ ☆
E/S DRAFT	: 0.0(m)				○ ☆

## 10. Contents of Menu Items

This section describes the menu items available with the addition of the CSH-5060 and external equipment.

### MENU-1 (SCAN, E/S Menu)

#### Scan menu

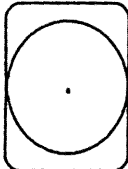
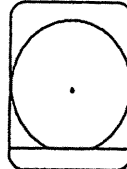
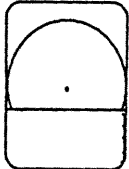
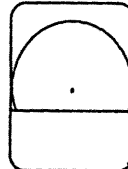
Item	Contents
MENU MODE	Selects a menu; MENU-1, MENU-2 or SYSTEM Menu.
DISPLAY MODE	<p>Selects a picture display mode among the four below.</p> <div style="display: flex; justify-content: space-around; align-items: center;"> <div style="text-align: center;">  <p>NORM</p> </div> <div style="text-align: center;">  <p>TEXT</p> </div> <div style="text-align: center;">  <p>COMBI 1</p> </div> <div style="text-align: center;">  <p>COMBI 2</p> </div> </div> <p>NORM: Normal Mode; displays a sonar picture on entire screen.            TEXT: Normal + Text; The text area appears on the lower area. This area is for displaying own ship's position, ship's speed, course, depth and tidal current.            COMBI 1: Sonar Combination (Normal + Signal on Bearing Mark); The echoes on the bearing mark direction appears on the lower 2/5ths of the screen.            COMBI 2: Echo Sounder Combination (Normal + Echo Sounder); When an external echo sounder is connected, the picture from the echo sounder appears on the lower 2/5ths of the screen.</p>
DELETE COLOR	Deletes echo colors whose strength is lower than the strength selected here. Useful for eliminating noise.
MARK ERASE (for scan menu only)	Selects the item to erase with the [TX] key; COURSE (track), SHIP (own ship mark), EVENT (event mark). Each pressing of the key deletes eldest track, ship or event mark.
RANGE/ BEARING (for scan menu only)	<p>This menu chooses the function of the [R/B] key.</p> <p>NORM - The echoes in the direction designated by the bearing mark are stabilized against the ship's pitching and rolling.</p> <p>TARGET - Echo designated by the target lock mark is automatically tracked.</p> <p>STAB, - Compensates for the effects of pitching and rolling. Requires Motion Sensor MS-100</p> <p>FISH/ALM Enables the user to set the fish alarm zone.</p>
FISH ALARM	Disables/enables the audio alarm for the fish alarm.
ALARM LEVEL	Chooses echo level which will trigger the fish alarm.

## E/S Menu

Item	Contents																																								
E/S SHIFT	<p>Shifts the start depth of the display range and the maximum value is about 1000 m irrespective of the depth unit. The unit shift value is determined by the range in use. See table below.</p> <table border="1" style="margin-left: auto; margin-right: auto;"> <thead> <tr> <th style="text-align: center;">\</th> <th style="text-align: center;">M</th> <th style="text-align: center;">FT</th> <th style="text-align: center;">FA</th> <th style="text-align: center;">P/B</th> </tr> </thead> <tbody> <tr> <td style="text-align: center;">1</td> <td style="text-align: center;">10</td> <td style="text-align: center;">25</td> <td style="text-align: center;">5</td> <td style="text-align: center;">5</td> </tr> <tr> <td style="text-align: center;">2</td> <td style="text-align: center;">20</td> <td style="text-align: center;">50</td> <td style="text-align: center;">10</td> <td style="text-align: center;">10</td> </tr> <tr> <td style="text-align: center;">3</td> <td style="text-align: center;">40</td> <td style="text-align: center;">100</td> <td style="text-align: center;">20</td> <td style="text-align: center;">20</td> </tr> <tr> <td style="text-align: center;">4</td> <td style="text-align: center;">50</td> <td style="text-align: center;">100</td> <td style="text-align: center;">25</td> <td style="text-align: center;">25</td> </tr> <tr> <td style="text-align: center;">5</td> <td style="text-align: center;">50</td> <td style="text-align: center;">200</td> <td style="text-align: center;">40</td> <td style="text-align: center;">40</td> </tr> <tr> <td style="text-align: center;">6</td> <td style="text-align: center;">100</td> <td style="text-align: center;">200</td> <td style="text-align: center;">50</td> <td style="text-align: center;">50</td> </tr> <tr> <td style="text-align: center;">7</td> <td style="text-align: center;">100</td> <td style="text-align: center;">300</td> <td style="text-align: center;">50</td> <td style="text-align: center;">50</td> </tr> </tbody> </table>	\	M	FT	FA	P/B	1	10	25	5	5	2	20	50	10	10	3	40	100	20	20	4	50	100	25	25	5	50	200	40	40	6	100	200	50	50	7	100	300	50	50
\	M	FT	FA	P/B																																					
1	10	25	5	5																																					
2	20	50	10	10																																					
3	40	100	20	20																																					
4	50	100	25	25																																					
5	50	200	40	40																																					
6	100	200	50	50																																					
7	100	300	50	50																																					
E/S IR	Turns the Interference Rejector on and off.																																								
E/S GAIN	Controls the gain of the Echo Sounder picture.																																								
E/S CLUTTER	Eliminates the noise appearing on the screen.																																								
E/S ADVANCE	Adjusts the picture advancement speed. 1/1 is fastest, 1/8 is slowest.																																								
E/S COL CURVE (Response Color Curve)	This menu sets the balance between weak and strong echoes. In the LINEAR position, output (echo strength displayed) varies proportionally with input (actual echo strength). Select a higher setting to emphasize weak echoes. Weak echoes are displayed in stronger echo colors as the number goes higher. The standard setting is the LINEAR position.																																								
E/S DRAFT	Adjusts the draft of the own ship according to loading conditions. Irrespective of the depth unit selection, the draft adjustment is available from 0 to 10 m in 0.5 m steps.																																								
E/S RANGE	<p>Selects the display range of the Echo Sounder from the table below.</p> <table border="1" style="margin-left: auto; margin-right: auto;"> <thead> <tr> <th style="text-align: center;">\</th> <th style="text-align: center;">M</th> <th style="text-align: center;">FT</th> <th style="text-align: center;">FA</th> <th style="text-align: center;">P/B</th> </tr> </thead> <tbody> <tr> <td style="text-align: center;">1</td> <td style="text-align: center;">20</td> <td style="text-align: center;">60</td> <td style="text-align: center;">10</td> <td style="text-align: center;">10</td> </tr> <tr> <td style="text-align: center;">2</td> <td style="text-align: center;">40</td> <td style="text-align: center;">120</td> <td style="text-align: center;">20</td> <td style="text-align: center;">20</td> </tr> <tr> <td style="text-align: center;">3</td> <td style="text-align: center;">80</td> <td style="text-align: center;">240</td> <td style="text-align: center;">40</td> <td style="text-align: center;">40</td> </tr> <tr> <td style="text-align: center;">4</td> <td style="text-align: center;">120</td> <td style="text-align: center;">360</td> <td style="text-align: center;">60</td> <td style="text-align: center;">60</td> </tr> <tr> <td style="text-align: center;">5</td> <td style="text-align: center;">160</td> <td style="text-align: center;">480</td> <td style="text-align: center;">80</td> <td style="text-align: center;">80</td> </tr> <tr> <td style="text-align: center;">6</td> <td style="text-align: center;">240</td> <td style="text-align: center;">720</td> <td style="text-align: center;">120</td> <td style="text-align: center;">120</td> </tr> <tr> <td style="text-align: center;">7</td> <td style="text-align: center;">320</td> <td style="text-align: center;">960</td> <td style="text-align: center;">160</td> <td style="text-align: center;">160</td> </tr> </tbody> </table> <p>Depth unit may be selected on the SYSTEM Menu.</p>	\	M	FT	FA	P/B	1	20	60	10	10	2	40	120	20	20	3	80	240	40	40	4	120	360	60	60	5	160	480	80	80	6	240	720	120	120	7	320	960	160	160
\	M	FT	FA	P/B																																					
1	20	60	10	10																																					
2	40	120	20	20																																					
3	80	240	40	40																																					
4	120	360	60	60																																					
5	160	480	80	80																																					
6	240	720	120	120																																					
7	320	960	160	160																																					

**MENU-2 (Refer to pages 47 to 51 for location on the screen.)**

Item	Contents
BEARING SCALE	This menu turns the electronic bearing scale on and off.
CURRENT MARK	This menu turns the current mark on and off.
COURSE MARK	This menu selects the length of the course line plot from 10R or 5R (R: range in use). If course line display is not necessary, select "OFF" to erase it.
HEADING INDI	Selects 32-azimuth or true bearing indication.
CURRENT INDI	Selects the current data indication method; 32-azimuth, true bearing or relative bearing ( $\pm 180^\circ$ or $360^\circ$ indication method)
EVENT IND	Selects the bearing data indication method of the even mark; 32-azimuth, true bearing or relative bearing ( $\pm 180^\circ$ or $360^\circ$ indication method)
MARK INDI	Selects the bearing data indication method of the trackball and bearing marks.
POSITION DATA	Selects the own ship's position display method, L/L or TD.

**SYSTEM MENU**

Item	Contents
SHIP' SPD/BR	This menu selects the source which feeds course line data.
LOG PULSE	Refer to the specifications of the speed log connected. The selections available are 200 or 400 pulses/mile.
CI BAUD RATE	Refer to the specifications of the equipment connected to the [CI] connector (current indicator). The standard setting is 4800 bps.
NAV FORMAT	Selects the format for data communication.
NAV BAUD RATE	Refer to the specifications of the navigation equipment connected to the [NAV] connector (loran, GPS, etc.). The standard setting is 4800 bps.
NAV DATA	This menu selects the navigation equipment which feeds position data to the CSH-8. If "ALL" is selected, the position data with the highest priority is chosen from plural data available; GPS has the highest priority and the LA, the lowest.
COMBI SCALE	This menu selects the location of the scale in the combination display mode.

# Indications

## 1. Normal Mode (NORM)

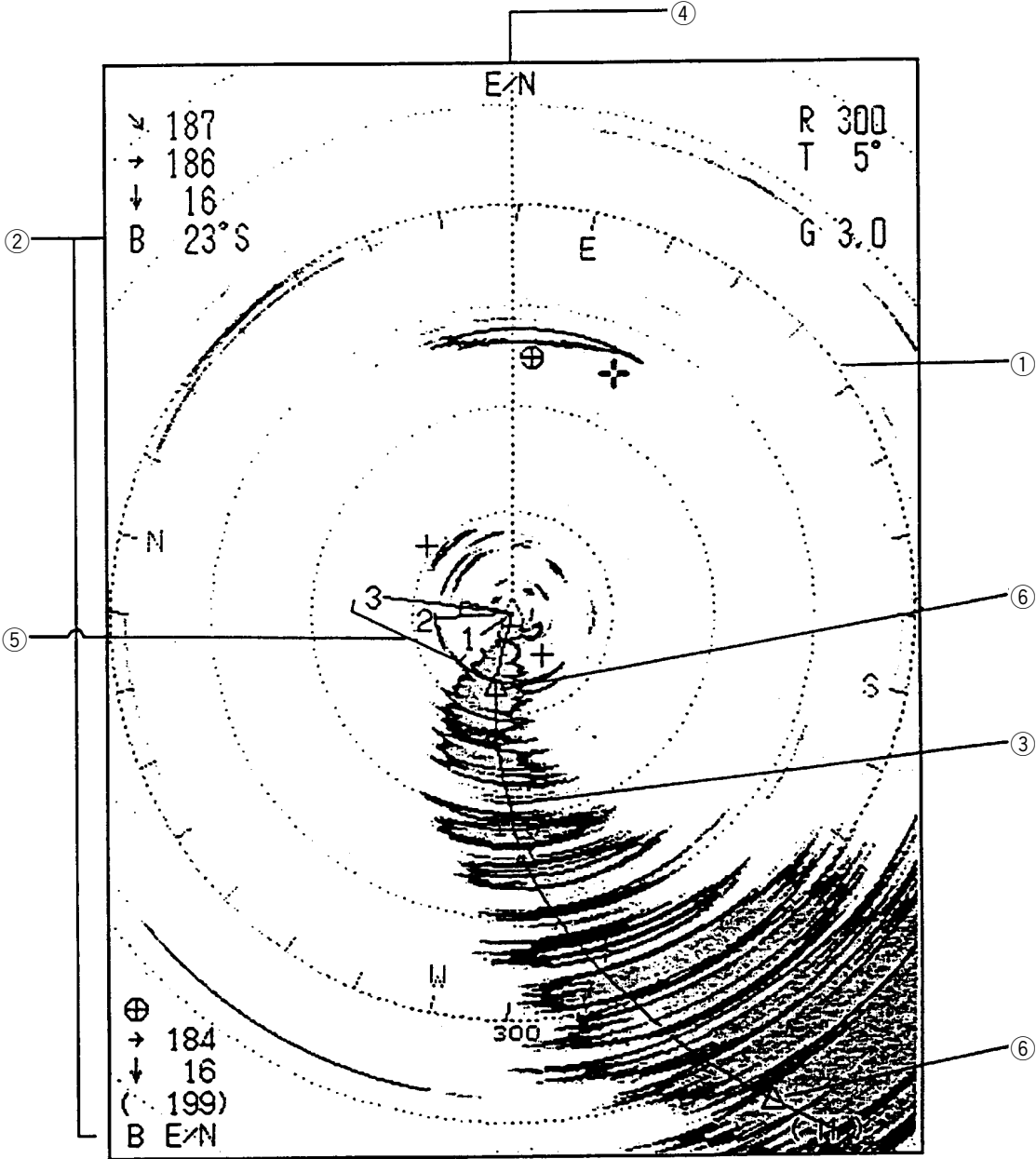

①	Electronic Bearing Scale	④	Heading Indication
②	Mark Indication (Bearing)	⑤	Current Mark
③	Course Mark	⑥	Own Ship's Mark

## 2. Normal + Text Mode

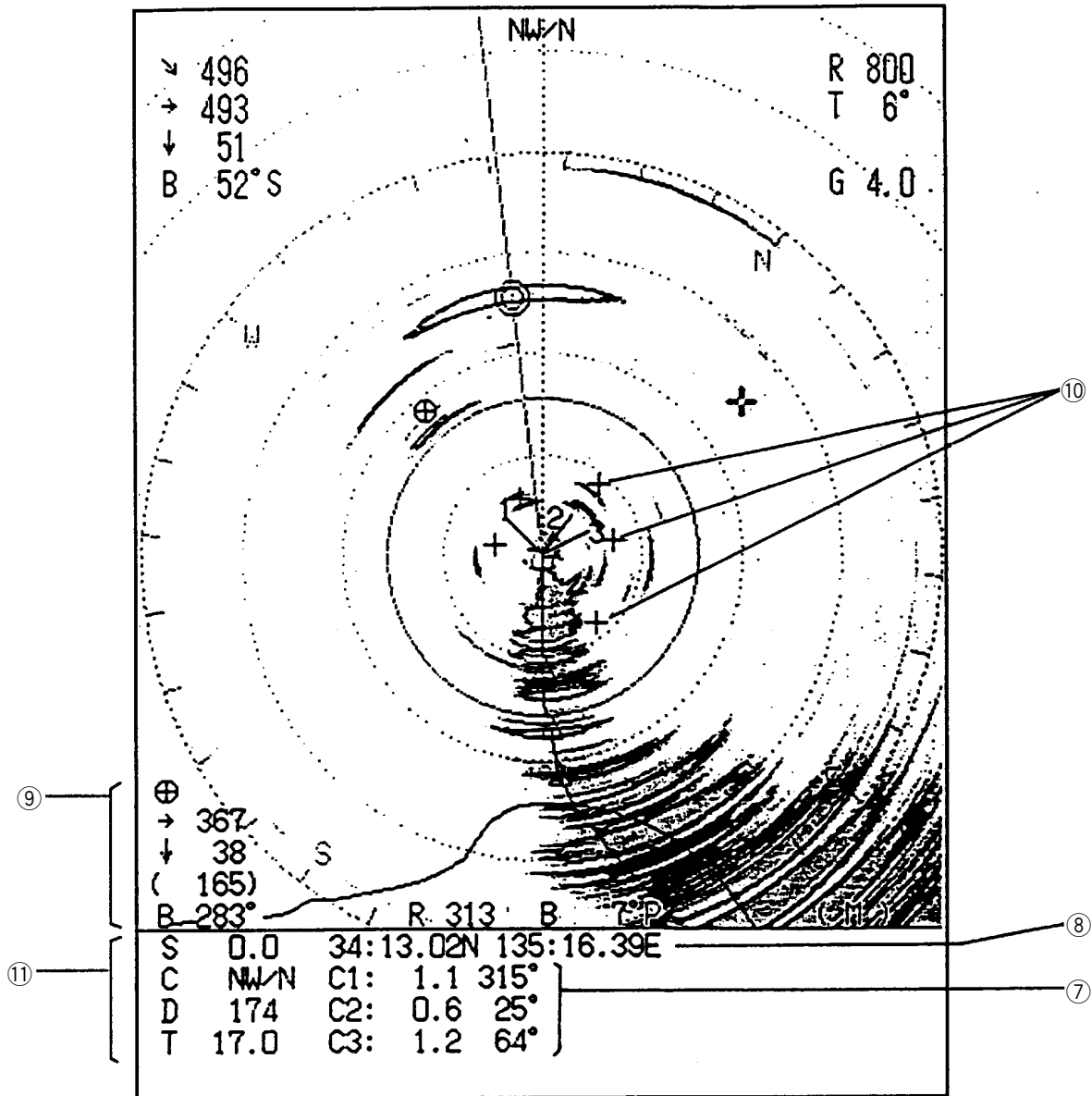

⑦	Current Indication	⑩	Past Event Mark
⑧	Position Data	⑪	Navigational Data
⑨	Latest Event Mark Data		

### 3. Echo Sounder Combination Mode (COMBI 1)

Normal + Echo Sounder

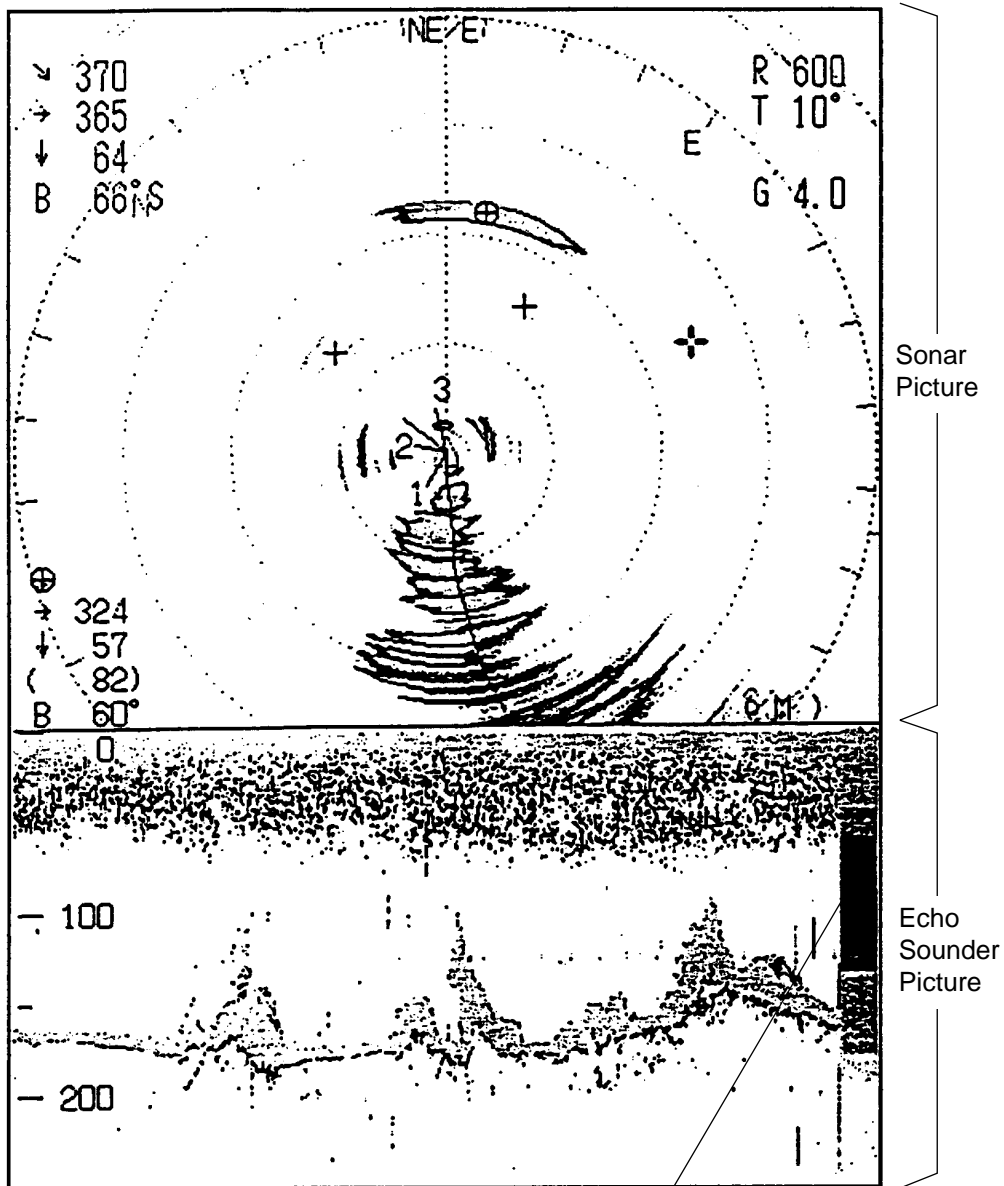

16 Color Bar

# 4. Sonar Combination (COMBI 2)

Normal + Signal on R/B Mark

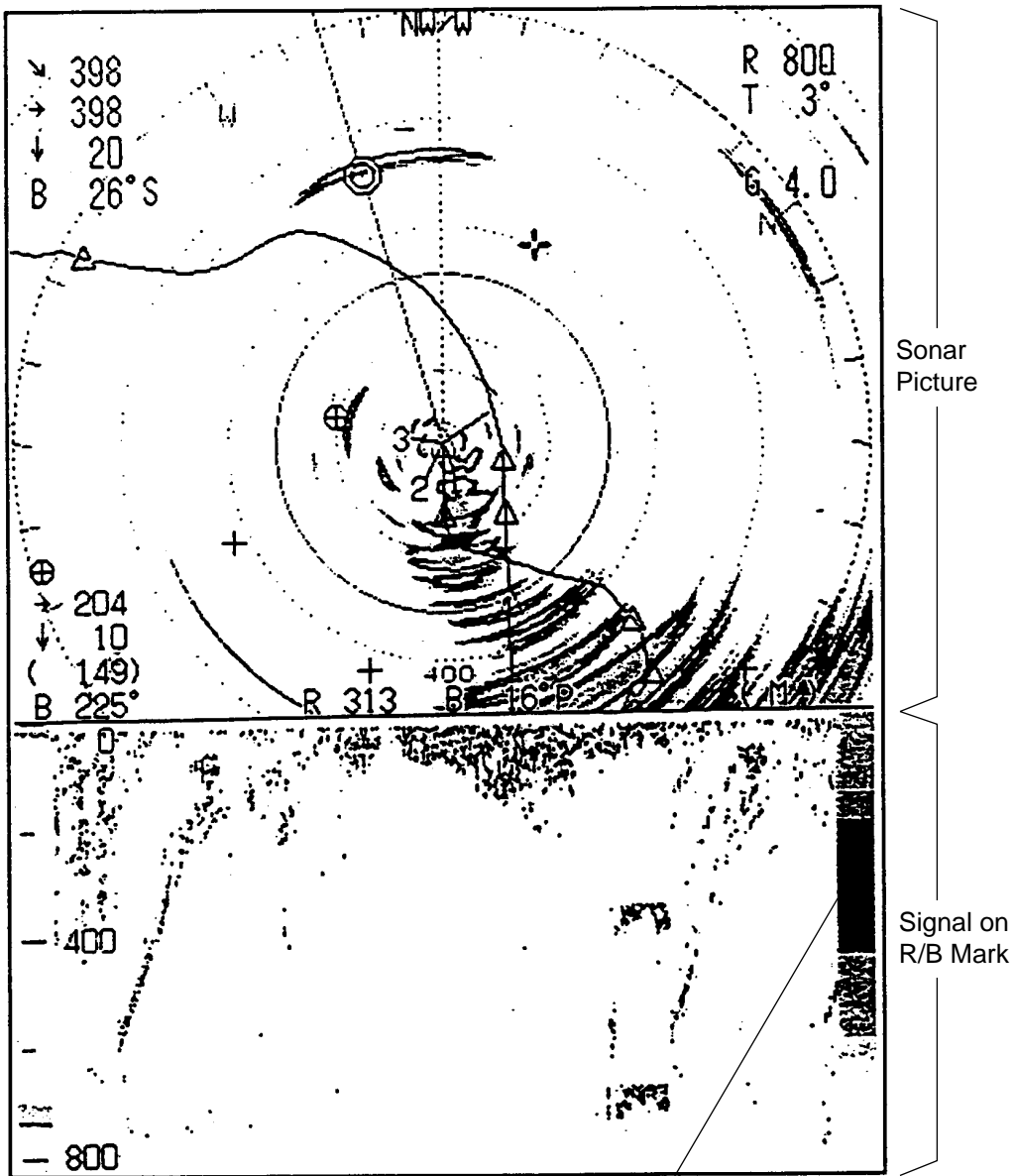







16 Color Bar

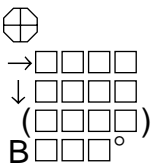

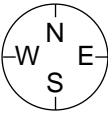
# Marks and Data

This section explains the Marks and Data available from the equipment interfaced. Pages 24 to 25 show the location of these Marks and Data.

New Marks and Data	Description
<p>Latest Event Mark Data</p> 	<p>The position data of the latest event mark, i.e., horizontal range (→), present depth (↓) and bearing. ( [ ] ) shows the latest event mark original depth which remains unchanged even if ship moves or tilt angle is changed. When the event mark is erased on the MENU screen, the above data disappear from the screen.</p>
<p>Own Ship's Mark</p> 	<p>You can plot up to 10 own ship's marks on the course line. The mark can be erased on the MENU screen.</p>
<p>Electronic Bearing Scale</p> 	<p>The electronic bearing scale is available with gyrocompass connection. It rotates with own ship's movement.</p>
<p>Course Line Mark</p> 	<p>The own ship's course line is plotted by a solid line when gyrocompass / speed log or a navigation device (GPS or Loran C) is connected. The course line length is selectable from 5 or 10 times the range in use. You can erase the line by the MENU screen.</p>
<p>Current Mark</p> 	<p>When a current indicator is connected, the current mark shows the speed and direction of three current layers, numbered 1 through 3. The current speed is indicated by the length of the vector. However, no vectors are developed if the current speed is 0.1 knots or less. The vector shows current direction. The current mark can be erased on the MENU screen.</p>
<p>Tridal Current Data</p> <p>C1: [ ] [ ] [ ] [ ]</p> <p>C2: [ ] [ ] [ ] [ ]</p> <p>C3: [ ] [ ] [ ] [ ]</p>	<p>In the Normal Mode (with Text), current speed and direction for three current layers appear in the text area. The display method for the current direction can be selected on the MENU screen.</p>
<p>Navigational Data</p> <p>S: [ ] [ ] . [ ]</p> <p>C: [ ] [ ] [ ]</p> <p>D: [ ] [ ] [ ] [ ]</p> <p>T: [ ] [ ] . [ ]</p>	<p>Own ship's speed(S), heading(C), water depth(D) and water temperature(T) can be displayed on the text area when appropriate equipment are interfaced.</p>
<p>Own Ship's Position Data</p> <p>[ ] [ ] ° [ ] [ ] . [ ] [ ] N</p> <p>[ ] [ ] ° [ ] [ ] . [ ] [ ] E</p>	<p>Own ship's position is shown in the Normal (with Text) mode (Position fixing equipment is required.)</p>
<p>North Mark</p> 	<p>The north mark is available with gyrocompass connection.</p>
<p>Target Lock Mark</p> 	<p>In the target lock mode (automatic echo tracking), the target lock mark appears when the [R/B] key is depressed. To erase the mark, press the [R/B] key again.</p>

## Event Mark Position Output

Connected to a navigator, the CSH-5 MARK-2 can output event mark position data to external equipment when the [EVENT] key is operated. The data sentence output is "SSTLL" (NMEA, IEC-1162 format).

# 12. MAINTENANCE

## General

The CSH-5 MARK-2 is designed and constructed to provide many years of trouble-free performance when properly maintained. User-performable maintenance and important points to be observed are outlined in the figure below.

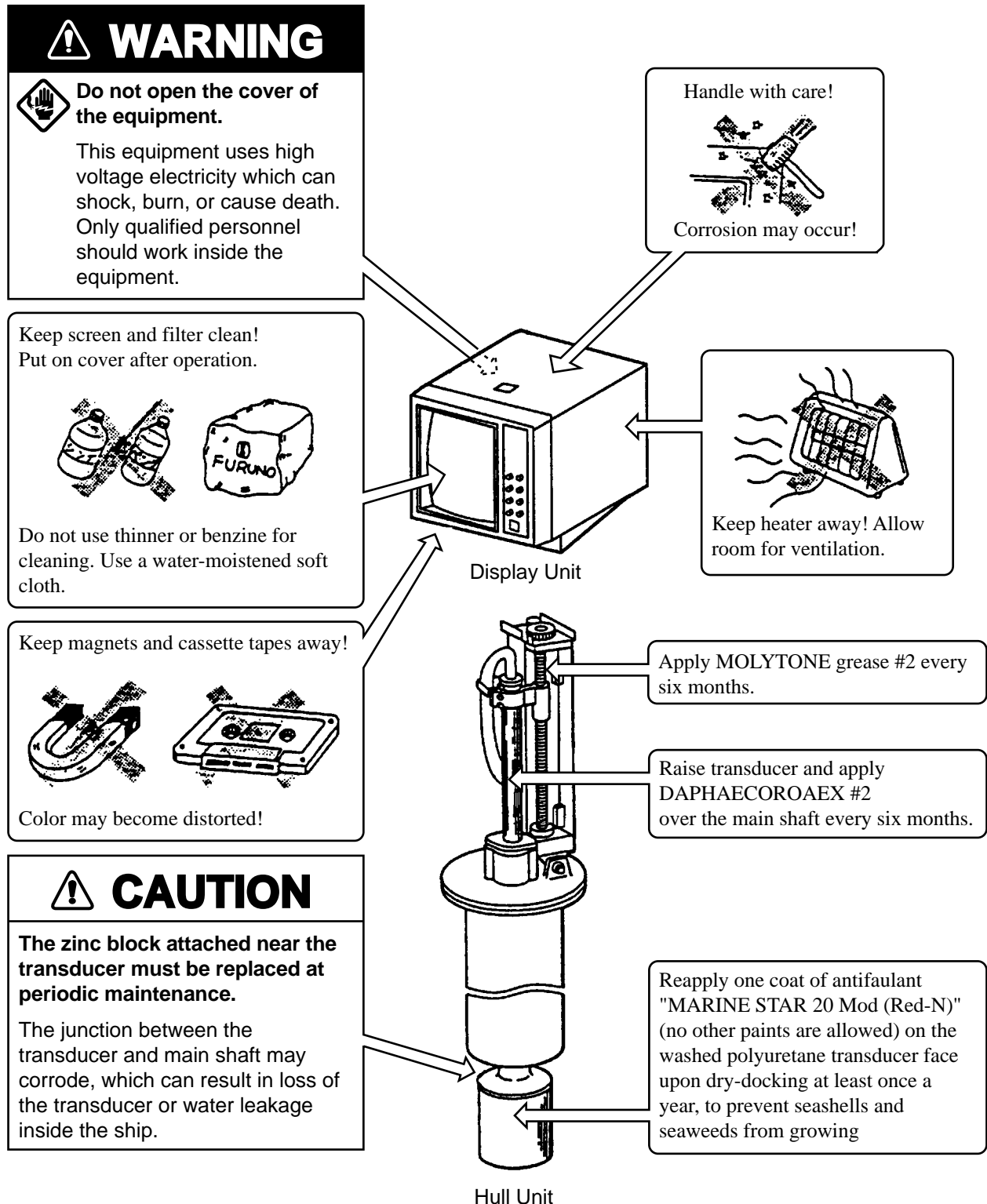

# 13. UNIT DIAGNOSTIC TESTS

This unit has eight built-in diagnostic tests which check it for proper performance. Although the tests are designed primarily for use by the service technician, they can also be executed by the user to identify defective components. However, never attempt to check inside the unit; there are no user-serviceable parts inside. Any repair work is best left to a qualified technician.

## Turning-on/off Diagnostic Test

1. Press the MENU key, and then select the system menu by operating the GAIN control.
2. Select the "SELF-TEST" function by operating the RANGE switch. Select an appropriate self-test by operating the GAIN control.

LANGUAGE	<b>ENGLISH</b>	JAPANESE	ESPAÑOL	DAN SK
SELF TEST	SINGLE	PANEL	COLOR	GRAY
	CONTI	SIO	ECHO-1	ECHO-2

3. Press the TX switch to execute the self-test.
4. To exit from the self-test screen, press the MENU key for a few seconds. When the "SINGLE" is selected, the unit automatically restores the system menu after the test is completed.

## Description of Unit-diagnostic Tests

### Single Test

This test checks the Main Board and Transceiver Unit for proper operation one time, after which normal operation is restored. After the test is completed, the results are indicated as OK (normal operation) or NG (malfunction), to the right of the device checked.

SINGLE TEST		
MAIN	105-0541-XXX	105-0542-XXX
	ROM = OK	
	RAM = OK	
	P.W = OK	
TRX	105-****-XXX	105-****-XXX
	ROM = OK	
	RAM = OK	
I/F	105-0267-XXX	
	ROM = OK	
	RAM = OK	

XXX : Version number

\*\*\*\*: 0635 ⇨ 107kHz  
0644 ⇨ 85kHz

Display Unit Program No. is displayed and ROM, RAM and P.W (Password) are checked for proper operation.

TRX (Transceiver) Unit Program No. is displayed, and ROM and RAM are checked for proper operation.

ROM and RAM of the interface module CSH-5060 (option) are checked for proper operation. If the interface module is not provided, program number and check result are not displayed.

## Conti Test

This is a continuous test of the Display and Transceiver Units. Additionally checked devices are DROM and DRAM.

```

CONTI TEST
MAIN 105-0541-XXX 105-0542-XXX
      ROM      = OK
      RAM      = OK
      P.W      = OK
      DROM     = OK
      DRAM     = OK
      DPRAM    = OK
TRX  105-****-XXX 105-****-XXX
      ROM      = OK
      RAM      = OK
      DROM     = OK
I/F  105-0267-XXX
      ROM      = OK
      RAM      = OK
      DPRAM    = OK
      GYRO     = OK
      LOG      = OK
PRESS [MENU] 2 or 3 SECONDS TO STOP SELF CHECK
  
```

\*\*\*\*: 0635 ⇨ 107kHz  
0644 ⇨ 85kHz

Not displayed if interface module CSH-5060 is not provided.

## Panel Test

This test checks the controls on the front panel and the control box for proper operation.

```

PANEL TEST

      0 0
      0 0
      • •
      • •

    0 0 0 0 0
      0 0 X = 0 0
      7 3 0 0 Y = 0
      0 0

PRESS [MENU] 2 or 3 SECONDS TO STOP SELF CHECK
  
```

Main Panel  
Press each control one by one.  
The figure should change if the control is functioning properly.

Control Box  
Repeat the above procedure.

## SIO Test

This test checks the input/output parts of the Transceiver Unit. The results of the test are indicated as OK or NG.

```

SIO TEST

MAIN SIO1 = OK
      SIO2 = OK

I/F  SIO-NAV = NG
      SIO-CI  = NG

PRESS [MENU] 2 or 3 SECONDS TO STOP SELF CHECK
  
```

SIO1: Checks communication line between display and transceiver unit.

SIO2, SIO-NAV and SIO-CI check communication line between interface module (option) and display unit. Short-plug is required to conduct this test.

## Color Test

The color test checks for proper display of all colors.

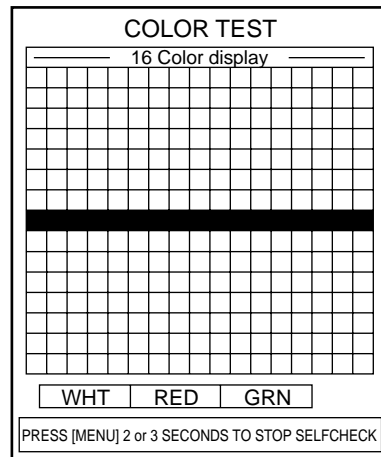

## Echo-1 Test

The echo-1 test checks echo processing circuits in the display unit for proper operation.

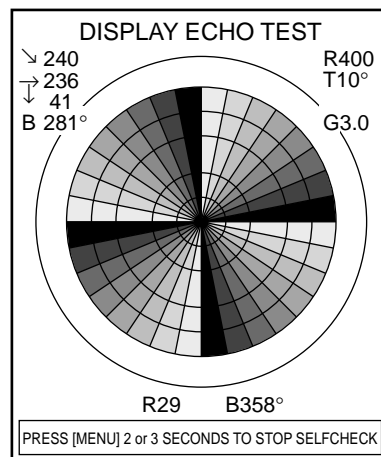

## Gray Test

The gray test checks for proper display of monochrome characters and markers. Concentric rings and a monochrome test bar are displayed.

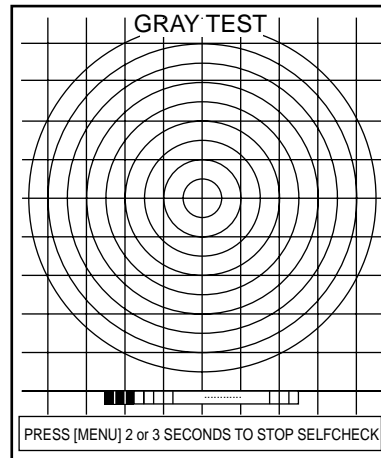

## Echo-2 Test

The echo-2 test checks echo processing circuits in the transceiver and display units.

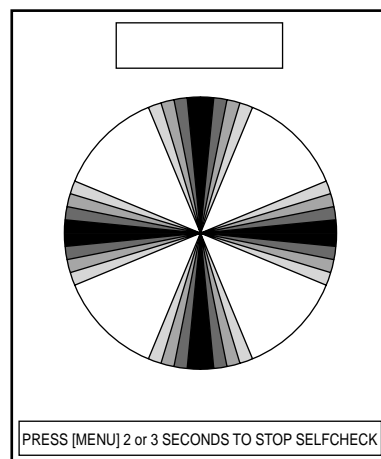

Set the VP control on the main panel to "OFF" position. Radial pattern as above is displayed.

# 14. CHARACTERISTICS OF THE ULTRASONIC WAVE IN WATER

The purpose of this chapter is to provide an overview of the characteristics of the ultrasonic wave in water.

## Sound Velocity

It is generally known that an ultrasonic wave travels 1500 meters per second in sea water, but in practice, some amount of variation arises depending on the season and area from differences in the following three factors:

- Water temperature .....  $\theta$  [ C ]
- Salinity density ..... S [%]
- Water pressure (water depth) ..... h [m]

Therefore, for propagation in surface water the velocity changes not only by area but also by direction of the wave propagation. The equation obtained thru numerous measurements is;

$$C = 1410 + 4.21\theta - 0.037\theta^2 + 1.145S + 0.0168h \text{ [m/s]}$$

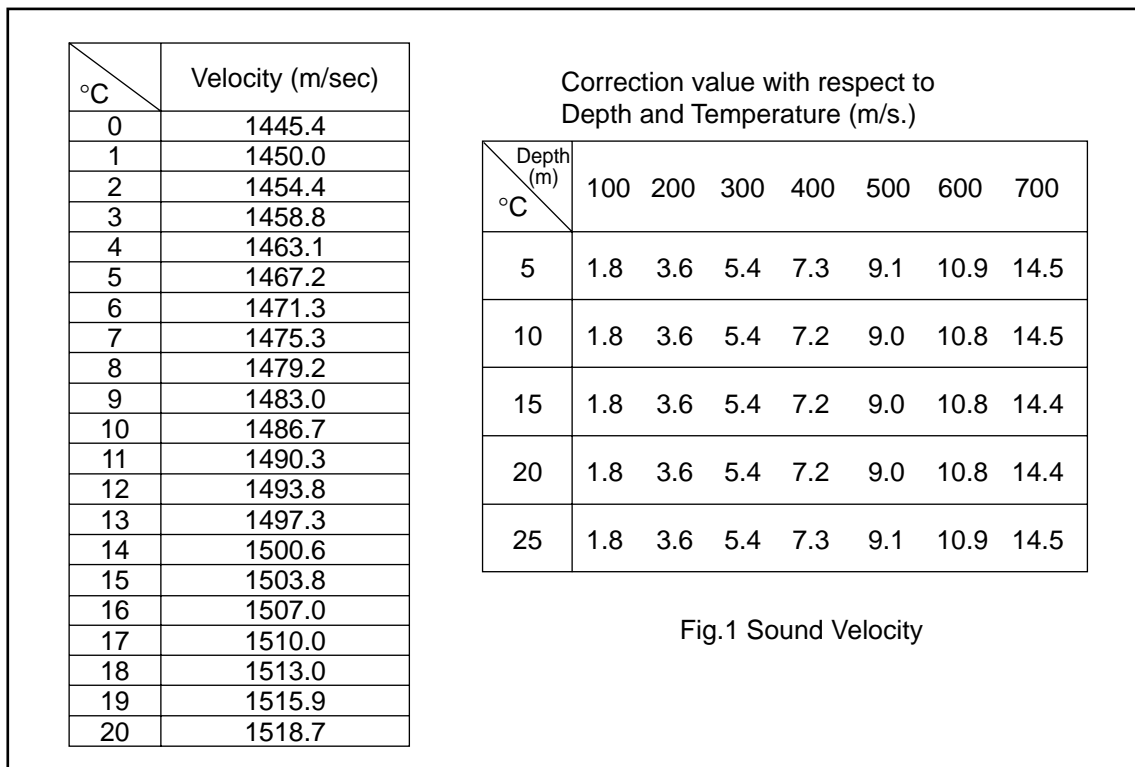

Fig.1 Sound Velocity



Research in the waters throughout the world has revealed that there is a difference of approximately 100 m/s between the areas where the velocity is maximum and minimum

Generally, the velocity increases as follows, provided that salinity density is constant:

- 3 m/s for every 1 degree rise of water temperature
- 1.7 m/s for every 100 m increase of water depth

## Absorption and Attenuation

An ultrasonic wave emitted into water becomes weaker in intensity as it goes away from the emitting source. Principle causes of attenuation are:

1. Acoustic energy of the ultrasonic wave decreases gradually through reflection, refraction and diffusion in water.
2. Acoustic energy is absorbed by the viscosity of the medium (water) and converted into other forms of energy.

The higher the frequency, the greater the absorption and attenuation of the ultrasonic wave as shown below. In other words, the absorption coefficient is a function of the frequency. Generally, total energy loss encountered on the way to and from a target is expressed

$$TL [dB] = 40 \log R + 2\alpha R$$

where R ----- Range to a target  
 $\alpha$  ----- Absorption coefficient

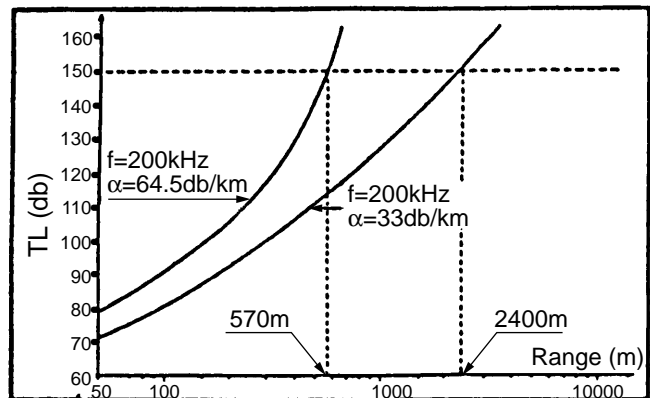
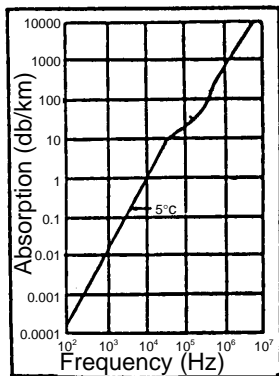

# Refraction

An ultrasonic wave transmitted in water does not travel straight but is more or less refracted. This refraction is caused by the variation of propagation velocity in water. If the velocity decreases (temperature decreases) with depth, the top part of the wave front moves faster than its bottom part, and gradually the front bends downwards. In the same way, it bends upwards if the sound velocity increases (temperature rises) with depth.

In other words, the ultrasonic wave refracts toward colder water.

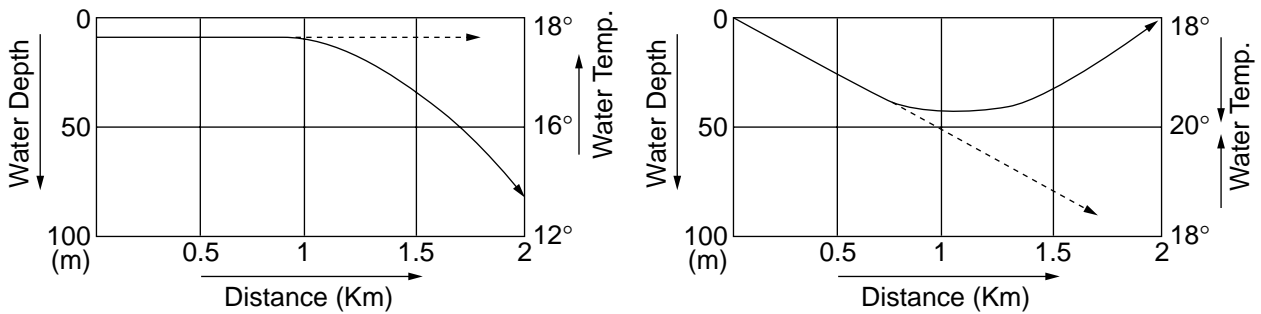

Here, a fishing ground off Hokkaido island in Japan is taken as an example.

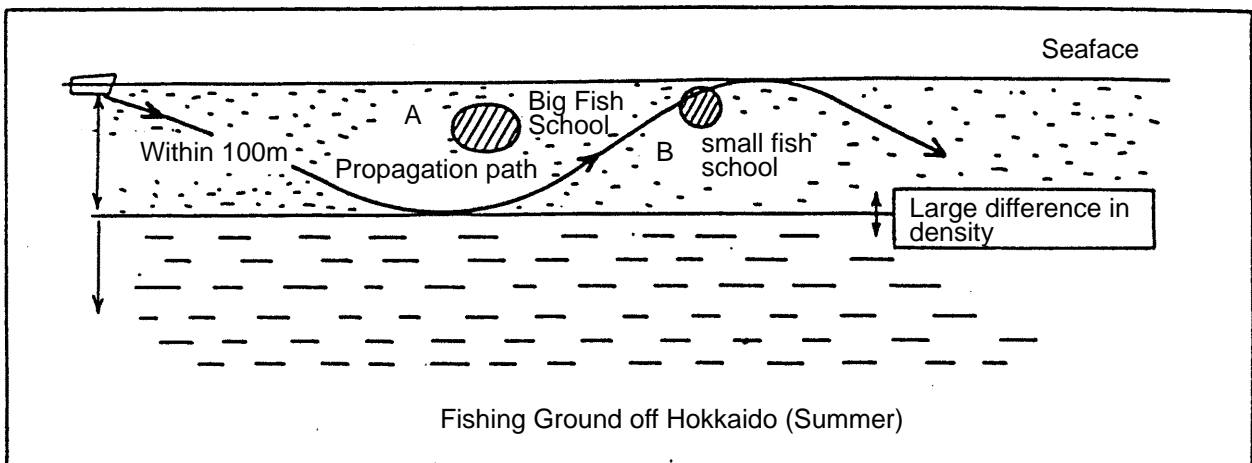

In summer, there is a large difference in salinity density below and above the 100 m deep point. An ultrasonic wave emitted almost in the horizontal direction propagates within 100 m deep water in the same way as a radio wave in a waveguide. As a result, even a small fish school is sometimes detected at an unexpected long range or on the contrary, detection of a large fish school does not extend to a relatively long range. These phenomena are encountered when two fish schools lie in positions "A" and "B" of the illustration.

The drawing below shows how temperature variation affects sound propagation with respect to different emitting directions (tilt angles).

Beams tilted five and ten degrees bend upward at 400 m and 600 m points respectively. Beams tilted down more than 15 degrees travel in almost straight lines. Between the two beams, a blind zone is created beyond the 600 m point. In this zone nothing can be detected. The shown drawing is only an example calculated by a computer, based on the temperature with depth as shown in the left column of the figure. In actual fishing grounds, the temperature distribution and subsequently the behavior of the sound beam is much more complicated. It is, therefore, for effective use of sonar, necessary to know at least roughly how the temperature is distributed in various waters.

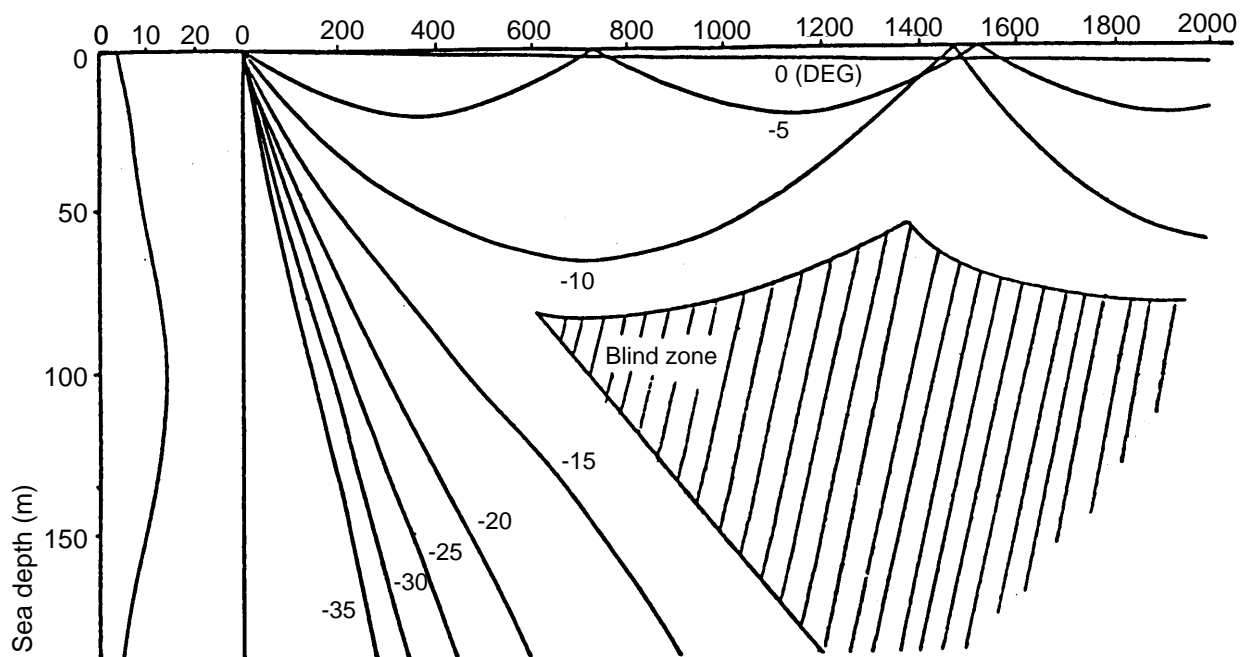

## Adverse Effect of Air Bubbles

Even infinitesimal air bubbles in sea water (liquid medium) affect propagation of ultrasonic sound. This is because the cubic elasticity of gas is extremely small when compared with that of liquid; the air bubbles violently vibrate (contract and expand) by the action of sound pressure, diffusing the ultrasonic wave and dispersing part of the acoustic energy. In a liquid which contains a large amount of air bubbles, attenuation of an ultrasonic wave increases and the wave is reflected at the boundary of waters which contain and do not contain air bubbles.

From the above it can be said that reflection occurs in the boundary where the density (P) of the material (medium) that is, the velocity of the ultrasonic wave changes. The velocity of an ultrasonic wave with respect to its medium is 200 thru 400 m/s in gas, except for hydrogen and helium; 900 thru 2000 m/s in liquid (several times higher than in air) and 2000 thru 6400 m/s in ordinary metal.

The product of the density (P) and the velocity (C) is called intrinsic acoustic impedance and in the boundary between two media which has extremely different C from each other, most of the acoustic power is reflected and only a small portion penetrates. (In the boundary between water and air, the acoustic energy penetrates with a loss of approximately 30 dB, that is approximately 0.1 % of the energy penetrates from one medium to the other.)

Reflection from water which contains air bubbles is caused by the fact that the cubic elasticity decreases in aerated water, causing the intrinsic acoustic impedance to change.

In the actual sonar operation, adverse effect of air bubbles is shown by interrupted display of target echoes which occurs while crossing over the wake of another boat or when the sonar transducer passes above the air bubbles generated by own ship.

Air bubbles in water have a resonant frequency of 15 kHz thru 100 kHz and hence the ultrasonic wave in this frequency range is most strongly affected.

## Reflection at Seabed and Fish School

The nature of the seabed is roughly classified into the following four kinds: crag, sand, mud and seaweeds. In addition, shells and carcass of animals (especially coral) imbedded in the seabed cause reflection loss.

$$\text{Reflection Loss } L_b = 20 \log \frac{\text{Incident sound pressure}}{\text{Reflection sound pressure}} \text{ (db)}$$

The actual reflection loss in the sea is shown below. The reflection loss remains almost constant up to 50 kHz and then gradually increases.

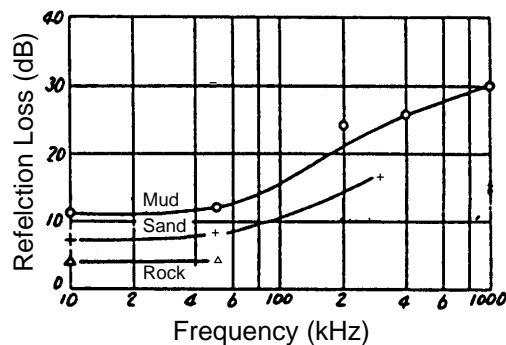

The relation of frequency vs reflection loss for mackerel is shown below. The calculated value and actually measured value nearly coincide. And also, on the contrary to the seabed reflection, the reflection loss decreases as the frequency increases. The “K” in the figure is the coefficient of fish shape, where its larger value introduces smaller reflection loss.

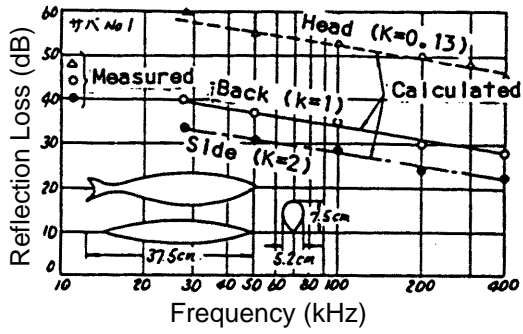

Reflection Loss  
(Mackerel No.1)

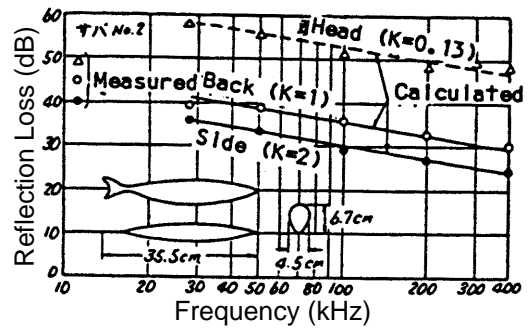

Reflection Loss  
(Mackerel No.2)

Species	Incident Direction of Ultrasonic Wave		
	Back	Side	Head
Sardine	1	2	0.13
Bonito	1	2	0.5
Horse Mackerel	0.8-1.2	1.4-2.2	0.4-0.6
Sea Bream	0.9	3	0.45
Turbot		2	
Average	1	2	0.4

# SPECIFICATIONS

## 1. Display

PPI display on 14" non-glare, high resolution color CRT

## 2. Display Color

16 colors according to echo strength

## 3. Numeric information

Scanning Data (Range, Tilt angle, Gain)  
Trackball Mark Data (Slant range, Horizontal range,  
Depth, Bearing)  
Range/Bearing Mark Data (Range, Bearing)

## 4. Range/Pulselength

Range

Basic Range(m)	Maximum Display Range (m)	
	OFF-Center "OFF"	OFF-Center "ON"
85	110	135
100	130	160
150	195	240
200	260	320
250	325	400
300	390	480
350	455	560
400	520	640
450	585	720
500	650	800
600	780	960
800	1040	1280
1000	1300	1600
1200	1560	1920
1600	2080	2560

**NOTE:** 1. Ranges shown for off-center "on" are maximum.  
2. Under certain circumstances, a target (fish school) may not be detected due to its nature or because of sea conditions, even if it is located within the display range.

Pulselength 0.5ms to 20ms, interlocked with range

PRR 0.2 sec to 4.0 sec interlocked with range. (can be changed in 11 steps.)

## 5. AUDIO SEARCH

Searching Method	Echoes in the direction of the bearing mark are audibly monitored by the built-in loudspeaker.
Audio Sector	20°, 40°, 80°, 120° (selectable)
Audio Output	2W
Audio Frequency	800Hz

## 6. Transmitter/Receiver

Transmitter	High power MOS FET amplifier with 11-step power reduction switch
Receiver	Low noise superheterodyne, continuously scanning beam forming
Tx Frequency	55kHz or 68kHz

## 7. Tilt Angle

Tilt Angle	0° to 55°
Auto Tilt	±2° to ±26° selectable

## 8. Hull Unit

	400mm travel	600mm travel
Transducer Travel	400m	600m
Raising Time	14 sec.	20 sec.
Lowering/Time	14 sec.	20 sec.
Driving System	Remote electric control	
Allowable Ship's Speed	18 knots max. (16 knots during raise/lower operation)	

## 9. Other Features

Interference Rejector, Video Processing, Noise Limiter, Automatic Tilt Scanning Overvoltage Warning, Unretracted Transducer Warning

## 10. Power Supply, Power Consumption

100/115/200/240VAC, 50/60Hz, 1 $\phi$ , 0.4kVA on average, 1kVA max. 24/32VDC with optional DC-AC inverter CSH-5050.

## A

Absorption 59  
AGC control 17  
Air bubbles 61  
Attenuation 59  
AUDIO control 21  
AUTO TILT key 6

## C

Color test 56  
Conti test 55  
Control box panel 5

## D

Data description 25  
DEMAG button 3  
Diagnostics  
  color test 56  
  conti test 55  
  echo-1 test 56  
  echo-2 test 57  
  gray test 57  
  panel test 55  
  single test 54  
  SIO test 55  
  turning on/off 54

## E

Echo-1 test 56  
Echo-2 test 57  
EVENT DELETE key 6  
EVENT key 6

## F

F1, F2 keys 22  
False echoes (sidelobe) 29  
Fish school echo 27

## G

GAIN control 5, 15  
Gray test 53

## I

Interface Module CSH-5060 35-51  
  available menu items 44-46  
  display marks 35  
  display mode 35  
  E/S menu 43

event mark 36  
indications 47-50  
marks and data 51  
menu description 41-43  
menu screen 40  
MENU-1 41  
MENU-2 42  
numeric information 35  
operation 36-46  
own ship mark 36  
SCAN menu 43  
specifications 35  
SYSTEM menu 42  
target lock mark 36

IR control 19

## M

Main panel 4  
Maintenance  
  zinc block replacement 53  
Mark description 24  
MENU key 5  
Menu operation  
  basic 7  
  scan menu operation 32  
  system menu description 33

## N

NOISE LIM control 18

## O

OFF-CENTER key 6, 22  
Output power 18  
Overvoltage remedy 30

## P

Panel test 55  
POWER switch 30  
Powering off 11  
Powering on 10  
Pulselength 17

## R

R/B key 6, 21  
Range and bearing measurement 20  
RANGE control 5  
RANGE switch 11  
Refraction 60



## **S**

Scan menu 8  
Sea surface reflections 28  
Seabed echo 26  
SECTOR SCAN key 6, 21  
Sidelobe 29  
Single test 54  
SIO test 51  
Sound velocity 58  
System configuration 2  
System menu 33

## **T**

Tilt angle  
    and discriminating fish echoes from bottom 12  
    for surface fish 13  
    general selection 11  
TILT lever 5, 11  
Trackball 5  
TRANSDUCER switch 5, 11, 30  
TVG adjustment 16  
TX cycle 19

## **W**

Wake recognition 28